



MSc Water Engineering and Management
Thesis

Combining river interventions to mitigate bed degradation in the Boven-Waal

R.M. ten Brink

Internal supervisors:

Dr. V. Kitsikoudis

Dr. Ir. D.C.M. Augustijn

External supervisors:

Ir. D. Booij

Dr. Ir. S. van Vuren

July, 2024

Preface

This master thesis marks the end of my academic journey, which started at the Rijksuniversiteit in Groningen with a Bachelor's in Spatial Planning and Design. I soon realized that my interest was not solely on the social aspects of spatial problems, but that I had a profound interest in the technical mechanisms behind them. This led me to the University of Twente, where I found that the Master's Civil Engineering and Management was better fitted towards my interests. More specifically, I discovered an unknown interest of mine in the functioning of rivers and coasts at the Water Engineering and Management department. The courses of the River and Coastal Engineering profile provided me with a solid foundation to deliver this end-product. Throughout this research, I delved into the intricate world of river morphology, specifically focusing on the hydraulic and morphological effects of combining various river interventions in the Boven-Waal. The knowledge and experiences gained during this research have significantly sharpened my understanding of river engineering.

I am grateful for the guidance and support of several individuals who supported me throughout this academic endeavor. First, I would like to express my gratitude to Danny Booij, my internal supervisor at Royal HaskoningDHV. Danny's daily supervision provided me with insightful ideas and his availability for discussing challenges ensured a streamlined researched process. It was a pleasant experience to go to the offices of Royal HaskoningDHV, where I felt included throughout my graduation process. Therefore, I want to thank Wiebe de Jong and Cas Pfeijffer for providing me with the opportunity to perform my master thesis as an intern at Royal HaskoningDHV. I also want to thank my supervisors from the University of Twente. Both Vasileios Kitsikoudis and Denie Augustijn have been helpful in the startup phase of this research, which allowed for the definition of an interesting and relevant master thesis topic. Their constructive feedback on my draft versions and our meetings enriched my work. Besides, their critical analysis encouraged me to dive deeper into certain important facets of morphological modelling. I specifically want to thank Vasileios Kitsikoudis for being flexible in reacting to unforeseen delays that were beyond my control, which allowed me to maintain focus and momentum. I also want to thank Saskia van Vuren from Rijkswaterstaat. Her practical insights and expert knowledge of the Dutch Rhine system added practical relevance to my research.

Finally, I want to thank my family and friends for their support during my graduation process, which kept me positive and motivated throughout my research. I also want to thank every colleague at Royal HaskoningDHV and external experts that have not been mentioned, but did contribute to my graduation process in some way.

I enjoyed the process of graduating and I hope this thesis contributes to the ongoing dialogue on the mitigation of bed degradation. I learned a lot from the graduation process, which will certainly help me in my future career.

I hope you enjoy reading my thesis.

Randy ten Brink
Nijmegen, June 2024

Abstract

The ongoing bed degradation in the Dutch Rhine delta hinders the achievement of goals set for the river areas within the Integrated River Management (IRM) programme. The Boven-Waal is currently the fastest degrading river branch, while also exerting a large influence on the discharge distribution at the Pannerdensche Kop, necessitating prompt intervention. Currently the potential of combining different river interventions to mitigate long-term bed degradation is underexplored. This research quantifies the effects of implementing different combinations of groyne lowering, longitudinal training dams and side channels with summer dike lowering in the Boven-Waal, on the mitigation of ongoing long-term bed degradation and its consequences. In order to achieve this, different combinations of river interventions have been schematized and simulated with the 2D 'Duurzame Vaardiepte Rijndelta' (DVR) model. The DVR model runs on the computational core of Delft3D and was made for the purpose of long-term morphological modelling by using a steady step hydrograph. The results indicate that the connection of lower lying areas in the floodplains of the meandering Boven-Waal via side channels, is unlikely to effectively mitigate ongoing bed degradation, due to limited space in the floodplains and the considerable amount of sediment that is deposited in the side channels. Instead, a combination of groyne lowering and longitudinal training dams in the Boven-Waal is identified as most effective for mitigating ongoing bed degradation. Promising development of the bed level of the Boven-Waal (+0.6 cm/year) is achieved. Besides, the desired discharge distribution at the Pannerdensche Kop, as defined in IRM, is close to being reached when combining groyne lowering and longitudinal training dams, which implies that this combination of river interventions is capable of diverting more discharge towards the Pannerdensch Kanaal during low discharges. Nevertheless, further optimization is necessary to achieve an optimal design for mitigating ongoing bed degradation, as the trade-off between navigability of the Boven-Waal and additional discharge to the Pannerdensch Kanaal during low discharges is delicate. The results contribute valuable insights to the already extensive knowledge base on river interventions, facilitating progress toward a comprehensive plan for addressing bed degradation in both the Boven-Waal and the Dutch Rhine delta as a whole.

Keywords: Morphological modelling; River interventions; Boven-Waal

Contents

1	Introduction	1
1.1	The current state of the Dutch Rhine branches	1
1.2	Problem statement	3
1.3	Study area	4
1.4	Research objective	7
1.5	Research questions	8
2	Theoretical Background	9
2.1	The general effect of a river intervention on morphology	9
2.2	The specific effects of certain river interventions on morphology	11
2.2.1	(Re)construction of side channels with summer dike lowering	11
2.2.2	Longitudinal training dams	13
2.2.3	Groyne lowering	14
3	Methodology	16
3.1	Model choice	16
3.2	Model domain	17
3.3	Functioning of the model	17
3.4	Difference between the old and intermediate version of the DVR model	20
3.5	Morphological spin-up	21
3.6	Performed simulations	22
3.6.1	(Re)construction of side channels with summer dike lowering (<i>SC</i>)	24
3.6.2	Longitudinal training dams (<i>LTD</i>)	26
3.6.3	Groyne lowering (<i>GL</i>)	28
4	Results	29
4.1	Analysis of the reference simulation	29
4.1.1	Hydraulics at the start of the simulation	29
4.1.2	Morphological development	32
4.2	Analysis of the schematised model simulations	36
4.2.1	Analyses of the division of discharge after 20 years for all simulations	36
4.2.2	Analyses of the morphological effect of Sim _{SC}	38
4.2.3	Analyses of the morphological effects of all simulations	41
4.2.4	Analyses of the effects on the consequences of bed degradation for all simulations	46
5	Discussion	54
5.1	Synthesis of the results	54
5.1.1	The maximum achievable mitigation of bed degradation via low effort side channel (re)construction and summer dike lowering	54
5.1.2	The mitigation of bed degradation for different combinations of river interventions	55
5.1.3	Effects of the different combinations of river interventions on the consequences of bed degradation	57
5.2	Reliability of the used methodology	58
5.2.1	Limitations of the DVR model	58

5.2.2	Reflection on the quality of the model output	61
6	Conclusion & Recommendations	66
6.1	Conclusion	66
6.1.1	Practical relevance for the future development of the Dutch Rhine branches	67
6.2	Recommendations	68
6.2.1	Validating DVR model	68
6.2.2	Optimising river interventions	68
Appendix A	Downstream boundary conditions	74
Appendix B	Checking for convergence	76
Appendix C	Assessment of the effect of morphological spin-up	79
Appendix D	Elaboration on the implementation of the different river interventions in the DVR model	83
Appendix E	Bed level development after 5, 10 and 15 years for the reference simulation	89
Appendix F	Bed level development after 20 years for each simulation	91

List of Figures

- 1.1 Overview of the part of the Dutch Rhine delta addressed by Table 1.1. The location relative to the Netherlands as a whole is shown. The thick black lines indicate the boundaries of the different river stretches, whereas the small black lines indicate each river kilometer. The value next to the thick black lines is the river kilometer belonging to that location. 2
- 1.2 The location of the Boven-Waal. The green rectangles show the location of the snapshots in Figure 1.3 (Total green rectangle) and Figure 1.4 (Upper section is right green rectangle and lower section is left green rectangle). 5
- 1.3 Overview of the Boven-Waal. The numbers represent the river kilometers (rkm) of each perpendicular black line in the Boven-Waal. The transparent grey background indicates the area within the winter dikes. The Pannerdensche Kop, where the Boven-Rijn bifurcates into the Pannerdensch Kanaal and Boven-Waal is visible in the east. 6
- 1.4 Water depth relative to the norm for ship navigation for the lower section (top) of the Boven-Waal, which ranges from rkm 880-892 in Figure 1.3, and for the upper section (bottom) of the Boven-Waal, which ranges from rkm 867-880 in Figure 1.3. The colorbars show the water depth relative to the norm for ship navigation. The colours yellow to red shows locations where the navigation depth is insufficient according to the norm. Green to blue colours show locations where the navigation depths are sufficient according to the norm. The current bottlenecks, the fixed layer at Nijmegen and the river bed groynes at Erlecom, can also be seen in the southern bends. The measurements in this map are based on a discharge of 1020 m³/s at Lobith (OLR). This map originates from Waterdieptekaarten Rijntakken (maps.rijkswaterstaat.nl). 6

- 2.1 The initial and long-term longitudinal effect of an extraction of discharge from the main channel on its bed. The first bold black arrow shows the start of the extraction of discharge. The second arrow shows where the discharge returns to its original amount again. This image is adapted from Paarlberg & Schippers (2020). 10
- 2.2 The left sketch shows an initial situation, where summer dikes are high and a lower lying area can be seen in the floodplain. The right sketch shows the situation after connection of the lower lying area in the floodplain to the main channel via implementation of side channels and the lowering/removal of summer dikes to the height of the surrounding area. This image is adapted from Ouwerkerk et al. (2023). 12
- 2.3 This sketch shows a longitudinal training dam (stone) that is already overflowing at its sill upstream. The crest of the longitudinal training dam is still above the water level and will only overflow for higher discharges. It replaced the groynes on the inner bend of the river, while the groynes in the outer bend remain. This image is adapted from Ouwerkerk et al. (2023). 14
- 2.4 This sketch shows eight groynes that have been lowered on either side of the main channel. They are already overflowed in this sketch. This image is adapted from Ouwerkerk et al. (2023). 15

- 3.1 The model domain of the DVR model. Each sub-domain is highlighted in a different colour. This figure is adapted from Ottevanger et al. (2015). 18

3.2	The hydrographs used at the upstream boundary. The yellow hydrograph was used in the old version of the DVR model. The blue hydrograph is used in the intermediate version of the DVR model.	21
3.3	Diagram that shows the performed simulations and the river interventions they comprise.	23
3.4	Currently present lower lying areas in the floodplains of the Boven-Waal (rkm 867-892 in Figure 1.3).	24
3.5	The grid of the DVR model in the Boven-Waal (rkm 868-887 in Figure 1.3). The grid cells of which characteristics have been adapted in order to connect the lower lying lying areas in the floodplains to the main channel are transparent. Black grid cells are unchanged.	25
3.6	Elevation map of the study area (rkm 867-888 in Figure 1.3). The existing summer dikes are visible within the black ovals. They are considerably higher than the rest of the surface of the floodplains. The approximate discharge at Lobith originally needed to overflow each summer dike is shown next to each summer dike. This map is adapted from AHN (ahn.nl).	26
3.7	The present weirs in the model input of the Boven-Waal (rkm 868-892 in Figure 1.3). The currently present summer dikes in the Boven-Waal, are schematized as weirs in the model input. The weirs marked in green represent the summer dikes and are removed. The weirs marked in red are unchanged.	26
3.8	The grid of the DVR model in the Boven-Waal (rkm 868-892 in Figure 1.3). The grid cells of which characteristics have been adapted in order to schematize LTDs are transparent. Black grid cells are unchanged. The yellow arrow indicates the outflow of the Spiegelwaal, where the LTD is interrupted by default in 'Globaal Ontwerp Langsdammen'.	27
3.9	Currently present groynes in the Boven-Waal (rkm 867-890 in Figure 1.3), are marked as dark blue lines. This map originates from Waterdiepte Rijntakken (maps.rijkswaterstaat.nl).	28
3.10	The present weirs in the model input of the Boven-Waal (rkm 868-892 in Figure 1.3). The currently present groynes in the Boven-Waal, are schematized as weirs in the model input. The weirs marked in green represent the groynes. The weirs marked in red are unchanged.	28
4.1	Comparison between the modelled water levels in the Boven-Waal by the DVR model at the start of Sim _{REF} (solid lines) and the Q/h relationship (dashed lines) of 2022 (Rura-Arnhem, 2022).	30
4.2	The discharge distribution at the Pannerdensche Kop for the nine different steady steps of the upstream hydrograph at the start of Sim _{REF}	31
4.3	Width averaged flow velocities in the main channel of the Boven-Waal at the start of Sim _{REF}	32
4.4	Yearly width averaged sediment transport in Sim _{REF} per upstream discharge coming from Lobith. A positive value indicates sedimentation (more sediment is entering the grid cell than leaving the grid cell). A negative value indicates erosion (more sediment is leaving the grid cell than entering the grid cell).	33
4.5	Cross-sectionally averaged bed level development through the 20 years of morphological simulation in Sim _{REF} in the Boven-Waal. The black line is a trend line.	33
4.6	Bed level change after 20 years for Sim _{REF} in the Boven-Waal. Positive (red) grid cells indicate sedimentation. Negative (blue) grid cells indicate erosion. The black line divides the Boven-Waal into two partial domains, these being the upstream (wl2a-1) and downstream (wl2a-2) part of the Boven-Waal, that each show different morphological change.	34

4.7	Domain averaged bed level change over the years compared to the start of Sim_{REF} . A positive value indicates domain averaged sedimentation, while a negative value indicates domain averaged erosion. A difference in morphological trend between the upstream part of the Boven-Waal (wl2a-1) and the downstream part of the Boven-Waal (wl2a-2) can be noticed.	34
4.8	Bed level at the start of the simulation for Sim_{REF} in the Boven-Waal. This includes the 2 years of morphological spin-up described in Section 3.5.	35
4.9	Bed level change through space (x-axis) and time (y-axis) for Sim_{REF} . An estimate of the propagation speed of the bed is shown in red.	35
4.10	Fraction of the flow passing through the main channel for all simulations compared to Sim_{REF} after 20 years. The actual discharge division of Sim_{REF} is shown, whereas the discharge divisions of the other simulations are relative to Sim_{REF} . Positive values indicate more flow through the main channel relative to Sim_{REF} . Negative values indicate less flow through the main channel relative to Sim_{REF}	37
4.11	Bed level development in the Boven-Waal after 20 years in Sim_{SC} , compared to Sim_{REF} . Positive values indicate sedimentation (red), while negative numbers indicate erosion (blue). The implemented side channels are numbered: 1 = Klompenwaard, 2 = Kaliwaal, 3 = Gendtsche Waard, 4 = Bizonbaai, 5 = Bemmelse Waard and 6 = Oude Waal.	38
4.12	Width averaged bed level development in the Boven-Waal after 20 years in Sim_{SC} , compared to Sim_{REF} . The x-axis shows the river kilometers from downstream (left) to upstream (right). The y-axis shows time in years. So every rectangle represents cross-sectional averaged bed level change at a certain location in the main channel of the Boven-Waal at a certain time in the simulation. Positive values indicate sedimentation (red), while negative numbers indicate erosion (blue). The implemented side channels are numbered: 1 = Klompenwaard, 2 = Kaliwaal, 3 = Gendtsche Waard, 4 = Bizonbaai, 5 = Bemmelse Waard and 6 = Oude Waal.	39
4.13	Domain averaged bed level development in the Boven-Waal throughout 20 years of morphological simulation. The blue lines represent the reference simulation (Sim_{REF}). The orange lines represent Sim_{SC} . The whole Boven-Waal is abbreviated to wl2a. The upstream section of the Boven-Waal is abbreviated to wl2a-1. The downstream section of the Boven-Waal is abbreviated to wl2a-2. A positive value indicates sedimentation averaged over the whole domain. A negative value indicates erosion averaged over the whole domain.	40
4.14	The domain averaged bed level development in the Boven-Waal for the different simulations throughout 20 years of morphological simulation (A). The domain averaged bed level development in the Boven-Waal split into an upstream and downstream section (B). The upstream section of the Boven-Waal is abbreviated to wl2a-1. The downstream section of the Boven-Waal is abbreviated to wl2a-2. Both are visible in Figure 4.6.	41
4.15	Bed level changes compared to Sim_{REF} after 20 years of morphological simulation in the Boven-Waal. Negative values indicate erosion after 20 years compared to Sim_{REF} . Positive values indicate sedimentation after 20 years compared to Sim_{REF} . Letters A and B denote the LTDs shown in Figure 4.16 and 4.17.	42
4.16	Depth averaged flow velocities (1) and water depths (2) in the riparian channel of the most downstream (A) and upstream LTD (B) in the Boven-Waal at a discharge of 1543 m ³ /s. The data in the plots is from $Sim_{SC-GL-LTD}$ after 20 years of morphological simulation.	44

4.17	Cross-sectional bed level changes in $\text{Sim}_{SC-GL-LTD}$ at the start of an LTD in the downstream section of the Boven-Waal (A) and in the upstream section of the Boven-Waal (B). The x-axis shows the cross-sectional width of the navigation channel by grid cell number.	44
4.18	Domain averaged bed level change per river branch compared to Sim_{REF} after 20 years.	46
4.19	Width averaged water depth during OLA ($1020 \text{ m}^3/\text{s}$) after 20 years along the Boven-Waal for the different simulations. The black horizontal line indicates a width averaged water depth of 4 meter that needs to be ensured (Rijkswaterstaat WVL, 2019).	47
4.20	Water depth during OLA ($1020 \text{ m}^3/\text{s}$) after 20 years along the Boven-Waal for Sim_{GL-LTD} . Red indicates a water depth below 2.8 meter and green indicates a water depth above or equal to 2.8 meter, which needs to be ensured (Rijkswaterstaat WVL, 2019).	48
4.21	Width averaged water depth during OLA ($1020 \text{ m}^3/\text{s}$) over the fixed layer after 20 years for all simulations. The black horizontal line indicates a width averaged water depth of 4 meter that needs to be ensured (Rijkswaterstaat WVL, 2019).	48
4.22	Width averaged water level during a discharge of $7009 \text{ m}^3/\text{s}$ after 20 years for all simulations. The values are compared to the water levels at the end of Sim_{REF} . Positive values indicate increased high water levels compared to Sim_{REF} and negative values indicated decreased high water levels compared to Sim_{REF}	50
4.23	The discharge distribution at the Pannerdensche Kop over the Boven-Waal and the Pannerdensch Kanaal after 20 years. All simulations are shown. The upstream steady discharge steps at which data is available can be recognized by the nine clusters of black dots. From left to right, these upstream discharges are $1020 \text{ m}^3/\text{s}$, $1294 \text{ m}^3/\text{s}$, $1543 \text{ m}^3/\text{s}$, $1954 \text{ m}^3/\text{s}$, $2601 \text{ m}^3/\text{s}$, $3384 \text{ m}^3/\text{s}$, $4353 \text{ m}^3/\text{s}$, $5506 \text{ m}^3/\text{s}$ and $7009 \text{ m}^3/\text{s}$	51
4.24	Percental change in discharge going to the Boven-Waal and Pannerdensch Kanaal at the Pannerdensche Kop compared to Sim_{REF} after 20 years. Each simulation has its own colour and each upstream discharge has its own marker type. The upstream left quadrant indicates that more discharge is flowing towards the Pannerdensch Kanaal compared to Sim_{REF} . The lower right quadrant indicates that more discharge is flowing towards the Boven-Waal compared to Sim_{REF}	52
5.1	Comparison between the domain averaged bed level change of the reference run of Pfeijffer (2023) on the left side and Sim_{REF} of this research on the right side. . . .	62
5.2	Comparison between the bed levels after 20 years for the reference simulation in the intermediate and newer version of the DVR model. Positive values indicate a higher bed level after 20 years in the reference run of the newer version of the DVR model. Negative values indicate a lower bed level after 20 years in the reference run of the newer version of the DVR model	63
5.3	Comparison between the domain averaged bed level change of the used intermediate version of the DVR model and the latest version of the DVR model. The solid lines indicate the domain averages of the newer version (NV) and the dashed lines indicate the domain averages of the intermediate version (IV).	64
B.1	Map showing the Pannerdensche Kop and the cross-sections in the Boven-Waal and Pannerdensch Kanaal used in Figure B.2.	77
B.2	Momentary discharges through the cross-sections at river kilometre 868 of the Boven-Waal and Pannerdensch Kanaal for the different upstream discharges of the DVR model in $\text{Sim}_{SC-GL-LTD}$	78

B.3	Momentary discharge through the cross-section at river kilometre 868 of the Boven-Waal for an upstream discharge of 7009 m ³ /s in Sim _{SC-GL-LTD}	78
C.1	Width averaged bed level change through the years of morphological simulation without morphological spun-up bed	80
C.2	Width averaged bed level change through the years of morphological simulation with morphological spun-up bed	80
C.3	Bed level change after 20 years of morphological simulation without morphological spun-up bed	81
C.4	Bed level change after 20 years of morphological simulation with morphological spun-up bed	81
C.5	Bed level change through time and space without morphological spun-up bed . . .	81
C.6	Bed level change through time and space with morphological spun-up bed	82
C.7	The development of the domain averaged bed degradation in the Boven-Waal, with (blue) and without (orange) morphological spin-up.	82
D.1	An overview of a grid cell of the DVR model. The bathymetry (.dep), sediment layer thickness (.fc) and sediment fractions (.frc) are defined on the black circles on the corners of a grid cell. The weirs and roughness values are defined in the velocity points, indicated by the grey lines on the edges of the grid cell. The black cross in the center indicates the water level point. The arrows in the sides show the longitudinal (V or n direction) and the cross-sectional (U or m direction)	84
D.2	The location of the implemented side channels is visualized by making the grid cells of which they consists of transparent. The black colour shows unchanged grid cells.	85
D.3	The weirs deleted for the implementation of side channels and lowering of summer dikes are shown in green. The weirs with a red colour have not been changed. . . .	85
D.4	The weirs that are changed for the lowering of groynes are shown in green. These weirs have been lowered to +1.20m OLR 2022. The weirs with a red colour have not been changed.	85
D.5	The location of the implemented longitudinal training dams is visualized by making the grid cells of which they consists of transparent. The black colour shows unchanged grid cells.	86
D.6	An example of how an LTD is schematized at rkm 882. The colours in the legend, ranging from dark blue to dark red, show the bathymetry. The black line represents the crest of the LTD and the grey line represents the sill of the LTD. The grid cells within the dashed brown polygon are the ones that were made to not contain a sediment layer.	87
D.7	An example of how an LTD is broken up to let a side channel bifurcate from the main channel at rkm 875. The yellow lines in the main channel are the LTDs. The LTD on the right is ending. The LTD is continued on the left with a new sill. The orange polygon is a bifurcating side channel that connects to a lake in the floodplain.	88
D.8	An example of how Sim _{SC-GL-LTD} is schematized between rkm 876 and 877. The colours indicate the elevation of the grid cells. The black polygons represent the crest of an LTD, the dark blue polygon represents the sill of the LTD, the purple polygons represent side channels and the white lines represent weirs. The white lines with a square at the tip are also weirs in the model schematization, but specifically represent groynes in this figure.	88
E.1	Bed level change after 5 years for Sim _{REF}	89
E.2	Bed level change after 10 years for Sim _{REF}	89
E.3	Bed level change after 15 years for Sim _{REF}	90

F.1	Bed level change after 20 years for Sim _{REF}	91
F.2	Bed level change after 20 years for Sim _{SC}	91
F.3	Bed level change after 20 years for Sim _{SC-GL}	92
F.4	Bed level change after 20 years for Sim _{SC-GL-LTD}	92
F.5	Bed level change after 20 years for Sim _{SC-LTD}	92
F.6	Bed level change after 20 years for Sim _{GL-LTD}	93

List of Tables

- 1.1 Averaged trends per river branch (cm/year), adapted from Sloff (2019). The 1st column shows the river branch with their corresponding river kilometers range in the 2nd column. 3

- 3.1 The performed model simulations for this research and the river interventions they include. 22
- 3.2 The elevation at which the side channels are connected to the main channel. 25

- 5.1 Domain averaged bed level change in cm/year for the intermediate and new version of the DVR model. 65

- A.1 Downstream boundary condition of the Beneden-Waal (wl2c). 74
- A.2 Downstream boundary condition of the Nederrijn (nr1a). 74
- A.3 Downstream boundary condition of IJssel (yac3). 75

1 | Introduction

In October 2023, a new policy (POW; Program under environmental Law) regarding river management was proposed in the Netherlands, called ‘Integrated River Management’ (IRM). IRM is a logical follow-up on the ‘Room for the River’ (RftR) programme that concluded in 2019. RftR was mainly focused on flood protection during high waters, while simultaneously improving spatial quality. This improvement of spatial quality was realised in different ways. Examples being parking spots, art or walking/cycling paths in the floodplains. This way, citizens became more engaged in the project, as the river areas could provide them with services. At the moment, Rijkswaterstaat aims to achieve many different goals in the river areas. These goals being safe discharge of high waters, nature, water quality, fresh water availability, drinking water supply and navigable rivers (Klijn et al., 2022). However, Rijkswaterstaat also realises that it is not possible to adapt the river areas in such a way, in which every goal is satisfied. Therefore, instead of planning to achieve each and every goal in the river areas, IRM seeks to find an optimal balance between the different goals. IRM is necessary, as climate change and its accompanying effects require this change in balance. On the one hand, climate change will cause more frequent and higher water levels during high discharges. On the other hand, climate change will also cause low discharges with lower water levels for longer durations. This development calls for rivers that are capable of increasing water levels during low discharges and decreasing water levels during high discharges (Klijn et al., 2022).

In their current state, the Dutch Rhine branches are not capable of this and their capability of dealing with all the different goals simultaneously is projected to worsen over time, due to ongoing bed degradation (Sloff, 2019). Bed degradation is defined as the ongoing erosion of the river bed, which compromises the achievement of set goals in IRM. For example, this ongoing bed degradation will have a large negative impact on navigability, flood protection, nature and the stability of structures (Barneveld et al., 2022). For instance, pipelines and cables will become exposed due to erosion of the riverbed, leading to their instability. Similarly, hydraulic structures that were designed for a certain riverbed height could become unstable with the ongoing erosion. Besides, if the water level in the river is lowered compared to its surrounding, it will lower groundwater tables. This will indirectly have an impact on nature, as water will be harder to reach for the roots of plants, causing them to dry out. So, the ongoing bed degradation in large parts of the Dutch Rhine branches has adverse effects. It shows that action is necessary to prevent these effects from happening. However, until today, it is still unsure how the this bed degradation problem can be tackled best and which river interventions should be performed to counter the ongoing bed degradation most effectively.

1.1 The current state of the Dutch Rhine branches

The river Rhine is a good example of a river system that is in morphological disequilibrium, as large parts of the river Rhine are affected by ongoing sedimentation and erosion (Frings et al., 2019). Human intervention has governed this morphological disequilibrium for the past century (Ylla Arbós et al., 2021) and thus current bed development in the river Rhine is induced by humans. For instance, the bifurcation (Pannerdensche Kop) where the river splits into the Waal and the Pannerdensche Kanaal (Figure 1.1) was designed for a certain discharge partitioning, enabling sufficient water to flow into the largest fresh water source of The Netherlands, the IJsselmeer (Barneveld et al., 2022). Another example of this anthropogenic influence is the cut-off of river bends for chan-

nelization at several locations between rkm 860-935, which led to a shortening of the river length by 10% between 1639-1776 (Ylla Arbós et al., 2021). These measures were intended for faster discharge of water and easier navigation, but they also induced several side effects in the form of increased riverbed erosion and ecosystem disruption. It shows that this anthropogenic altering of the morphologies of rivers has been going on for centuries (Mosselman, 2022; Ylla Arbós et al., 2021).

The river Rhine in the Netherlands is by no means a result of natural processes anymore. The morphological disequilibrium in the Dutch Rhine branches is currently causing ongoing bed degradation. This bed degradation is caused by the water flow, which has a larger sediment transport capacity than the upstream availability of sediment. This will cause the riverbed to erode in the years to come, if no action is undertaken (e.g., Blom, 2016; Sloff, 2019). This erosion of the bed can be up to two centimetres per year, but it is not equal throughout the different branches of the Rhine (Sloff, 2019). Sloff (2019) made a prognosis based on extrapolation of long-term trends per river branch. Sloff (2019) found that projecting current trends results in a bed degradation of 0.6 and 1.6 centimetre in the Midden-Waal and Boven-Waal respectively. Oppositely, aggradation of 0.1 centimetre per year may occur in the Beneden-Waal. Besides, the degradation in the Pannerdensch Kanaal is estimated to be 1.0 centimetre per year. This is less than the degradation in the Boven-Waal, which implies that the discharge distribution at the Pannerdensch Kop will skew more and more towards the Waal in the future (Chowdhury et al., 2023). This would cause the north and east of the Netherlands to get less water. However, similar as to in the past, human interventions downstream of the Pannerdensch Kop can alter the discharge partitioning again. This time, it can be changed to suit the goals defined in IRM. Several different river interventions can be applied to reach these goals, via the induction of changes in hydraulics and morphology in the river branches (e.g., Chowdhury et al., 2023; Pfeijffer, 2023; Rorink, 2022; Welsch, 2021). Table 1.1 shows trends based on measured bed level data of different researchers and institutes. Although some small differences can be found in these trends, the ongoing trend as described in this paragraph is unanimously present.

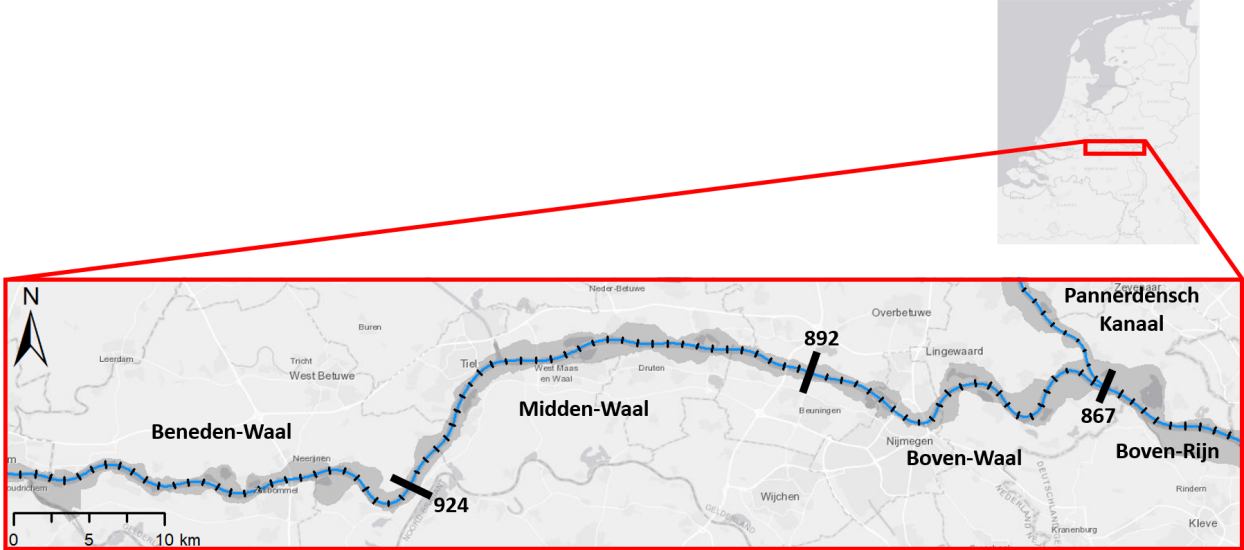

FIGURE 1.1: Overview of the part of the Dutch Rhine delta addressed by Table 1.1. The location relative to the Netherlands as a whole is shown. The thick black lines indicate the boundaries of the different river stretches, whereas the small black lines indicate each river kilometer. The value next to the thick black lines is the river kilometer belonging to that location.

TABLE 1.1: Averaged trends per river branch (cm/year), adapted from Sloff (2019). The 1st column shows the river branch with their corresponding river kilometers range in the 2nd column.

River branch	River kilometer	Ten Brinke (2019)	Ylla Arbós et al. (2019)	Sloff et al. (2014)	Sloff (2019)
Boven-Rijn	858 - 857	+ 0.1	+ 1.3	+ 0.2	0.0
Boven-Waal	868 - 885	- 1.9	- 1.6	- 2.0	- 1.6
Midden-Waal	886 - 933	- 0.4	- 0.3	- 0.2	- 0.6
Beneden-Waal	934 - 951	+ 0.1	+ 0.2	+ 0.1	+ 0.1
Pann. Kanaal	868 - 876	- 1.1	- 1.4	- 1.2	- 1.0

1.2 Problem statement

Many different river interventions in the Dutch Rhine branches have been researched in the past. Oldenhof (2021) and Welsch (2021) both looked at the influence of several river interventions, including side channels, lowering of floodplains and removal of obstructions. Additionally, Oldenhof (2021) also investigated the influence of widening the riverbed and dike relocation. Oldenhof (2021) used a 1D model to merely enable a quick estimation of the morphological effects of these river interventions. Although Welsch (2021) used a 2D model, Welsch (2021) only implemented a single simulation in which the river interventions were all combined, without attention for the cumulative effect of single river interventions. Therefore, it could be that certain river interventions that Welsch (2021) implemented, added little to no additional value to the morphological situation at the end of the simulation. This could not be determined by the single simulation of Welsch (2021), which combined all interventions from the 'Room for Living Rivers' vision (Beekers et al, 2018).

Floodplain lowering has also been simulated in the Boven-Rijn and Waal in the research of Ylla Arbós et al. (2024), but it was found that it could not stop bed degradation, it could only mitigate it by about 0.2 meter after 50 years. This was found by using a 1D model, which does not account for summer dikes. Currently, the potential of lowering of summer dikes is not exactly known, even though they often determine the moment at which floodplains overflow. Lowering of summer dikes is a low effort intervention to perform, compared to lowering of the whole floodplains.

Pfeijffer (2023) and Rorink (2022) both looked at a single river intervention, respectively longitudinal training dams and side channels. Both Rorink (2022) and Welsch (2021) found that river interventions only showed local effects that remained close to the river interventions. Similar to Oldenhof (2021), the performed research of Rorink (2022) only investigated side channels using a 1D model. Rorink (2022) chose several fixed locations for side-channels in the Dutch Rhine branches, where a systematic analysis on the influence of different activation frequencies of side channels based on the discharge coming from Lobith was performed. Rorink (2022) found that side channels had potential to reduce the bed degradation in the Waal and Pannerdensch Kanaal by 10-15%. In the study of Pfeijffer (2023), where longitudinal training dams (LTDs) were implemented along the whole Midden-Waal and Boven-Waal, widening the riparian channel from 200 metres to 225 metres led to the most improved river Waal. In the sense that it reduced erosion, caused the most promising navigation depths, lowered the water level during high discharge and it improved the discharge distribution at the Pannerdensche Kop. Lowering the sill height from +0.5 meter OLR to 0 meter OLR and lowering the crest height of the LTDs from +2 meter OLR to +1.2 meter OLR led to worse results in the research of Pfeijffer (2023). This gives a sense of what the most ideal LTD geometries could be. However, it should be noted that Pfeijffer (2023) also mentions that the found differences were small. So, optimization efforts in this study might better be focused elsewhere. Even though the research of Pfeijffer (2023) gave some insight into the sensitivity to changes in climate and geometry of longitudinal training dams in the Waal, the

used 2D model in both the study of Pfeijffer (2023) and Welsch (2021) was known to be inaccurate in several river branches, including the studied Waal, which adds considerable uncertainty to the results of these studies.

Lastly, all mentioned river interventions were implemented with different geometries and at different locations. Similarly, the outcomes are results produced by a variety of models, which all have their own inaccuracies and uncertainties. However, previous research concludes unanimously that a single river intervention is not the solution to the problem at large (e.g., Liptiay, 2023; Pfeijffer, 2023; Rorink, 2022; Ylla Arbós et al, 2024). Instead, it is suggested that a combination of river interventions might be necessary. However, to design a complete package of river interventions that works optimal for the mitigation of ongoing bed degradation, it has to be known how river interventions behave when they are implemented simultaneously. This way, the potential of river interventions in mitigating or perhaps even stopping the ongoing bed degradation can be explored even further. Until now, a study that aims to explore the cumulative effects of river interventions when they are implemented simultaneously, has not been performed. Especially not with a 2D model, which seems to be required in winding river sections, such as the Boven-Waal. If a better understanding is gained about the mutual effect of river interventions, it enables the design of a more optimal package of river interventions for countering the ongoing bed degradation in the Dutch Rhine delta.

1.3 Study area

The Boven-Waal is selected as the study area of this research. This choice is driven by the current morphological trends, the large meanders and the considerable effect that the Boven-Waal has on the functioning of the Dutch Rhine delta as a whole (Figure 1.2 and 1.3). Figure 1.4 shows two features in the southern river bends of the Boven-Waal, these features being a fixed layer at Nijmegen and river bed groynes at Erlecom. These interventions were made in the past in order to improve navigability. The fixed layer at Nijmegen was constructed to prevent the outer bend from eroding into the city of Nijmegen. The river bed groynes at Erlecom were built later for similar reasons. They limit erosion in the outer bend, hereby causing additional erosion in the inner bend, which in turn creates a wider navigation channel. However, these past interventions currently lead to unwanted effects and pose a potential bottleneck for safe ship navigation. Especially in combination with an eroding summer bed, these river sections will lead to big navigation problems at low discharges. As the summer bed erodes deeper into the landscape, the height difference between the fixed layers and the summer bed becomes bigger, eventually leading to insufficient water depth at these bottlenecks (Ministerie van Infrastructuur en Waterstaat, 2023), which again shows the urgency of mitigating bed degradation and its consequences for the Boven-Waal.

Interventions that are taken in the Boven-Waal will have an immediate effect on the discharge distribution at the Pannerdensch Kop, which is visible in the upper section of the Boven-Waal in Figure 1.4. Here the Boven-Rijn bifurcates into the Boven-Waal and the Pannerdensch Kanaal. It is interesting to analyse what happens at the Pannerdensch Kop, while a combination of river interventions is implemented in the Boven-Waal. This can shed light on the amount of river widening measures needed in the Pannerdensch Kanaal to have a desired discharge distribution at the Pannerdensch Kop, when a combination of interventions is implemented in the Boven-Waal.

Generally, raising of the main channel bed level of a river can be achieved by fixing the division of discharge flowing through the summer and winter bed (Klijn et al., 2022). More discharge should flow through the winter bed of the Boven-Waal, while less discharge should flow through the summer bed of the Boven-Waal, hereby reducing the erosion in the main channel. Raising

the bed level of the Boven-Waal becomes even more important when the discharge distribution at the Pannerdensche Kop is restored. Currently, IRM aims for a minimum of 22% of the upstream discharge in the Boven-Rijn to end up in the IJssel during low discharges. Besides, when upstream discharge is decreasing, a minimum of $315 \text{ m}^3/\text{s}$ should flow into Pannerdensch Kanaal. So when restoring the discharge distribution at the Pannerdensche Kop, it is certain that less water will flow to the Boven-Waal during low discharges. This in turn, will worsen the already present navigation depth problems in the Boven-Waal due to previously mentioned bottlenecks, which are the fixed riverbed at Nijmegen and the river bed groynes at Erlecom (Figure 1.4). It is desired to increase the navigation depth here.

Figure 1.3 shows that the Boven-Waal has large meanders. These bends induce 3D effects, such as spiral flow and sorting effects, which have a great influence on the flow (Clayton, 2010). This leads to lateral differences in the riverbed (Welsch, 2021). So, the inner and outer bend of a river develop differently. This lateral sediment sorting mechanism is caused by a difference in interaction between gravity and shear stress exerted by the bend flow on the different grain sizes (Baar et al., 2020). Gravity causes the heavier sediment grains to move downslope towards the outer bend of the river, while secondary flow drags the finer sediment grains upslope towards the inner bend. This finer sediment in the inner bend causes higher sediment transport in the inner bend compared to the outer bend, hereby creating larger bed forms in the inner bend (Sloff, 2022). Previous research with 1D models acknowledges that these processes have not been captured (e.g., Liptiay, 2023; Rorink, 2022). So, if action is undertaken in the Boven-Waal, this will induce effects that cannot be captured by a 1D model. Such 3D processes can be captured more accurately with a 2D model, via usage of parameterizations.

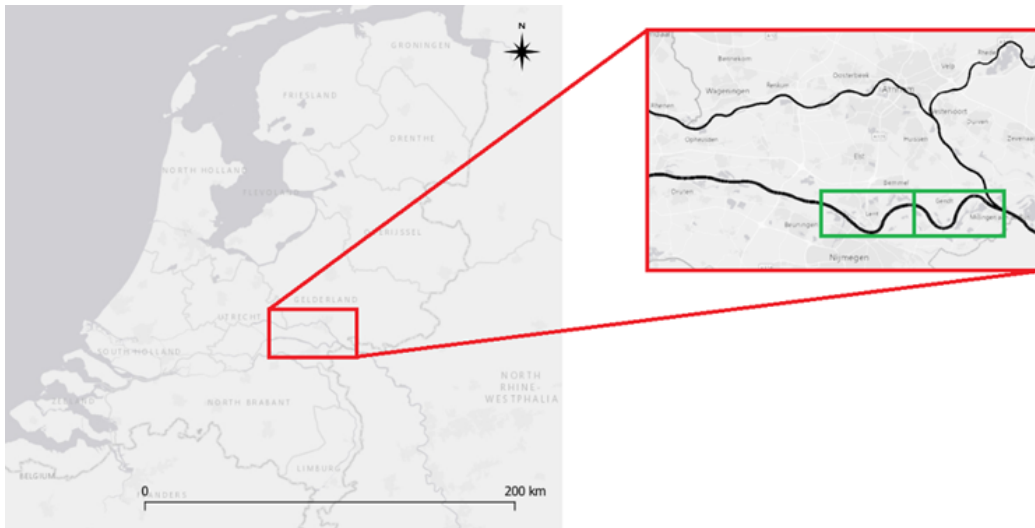

FIGURE 1.2: The location of the Boven-Waal. The green rectangles show the location of the snapshots in Figure 1.3 (Total green rectangle) and Figure 1.4 (Upper section is right green rectangle and lower section is left green rectangle).

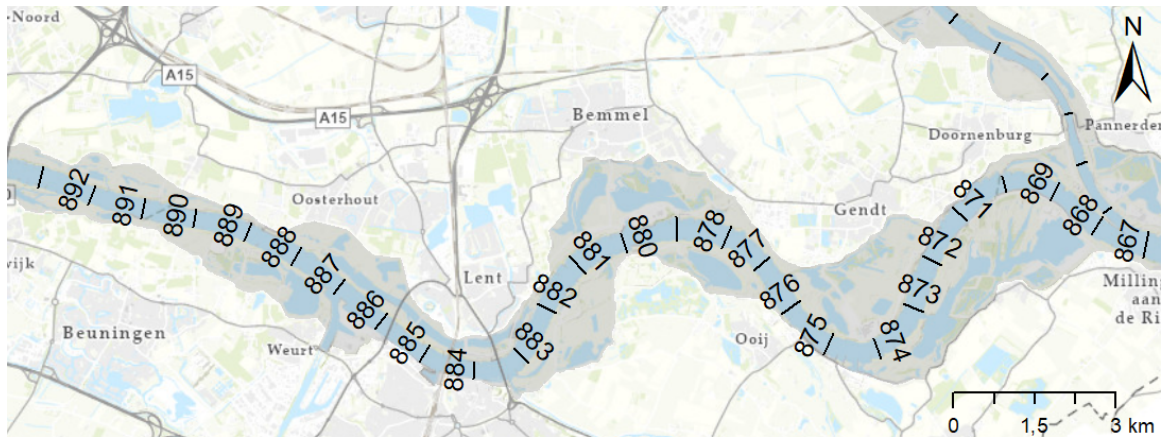

FIGURE 1.3: Overview of the Boven-Waal. The numbers represent the river kilometers (rkm) of each perpendicular black line in the Boven-Waal. The transparent grey background indicates the area within the winter dikes. The Pannerdensche Kop, where the Boven-Rijn bifurcates into the Pannerdensch Kanaal and Boven-Waal is visible in the east.

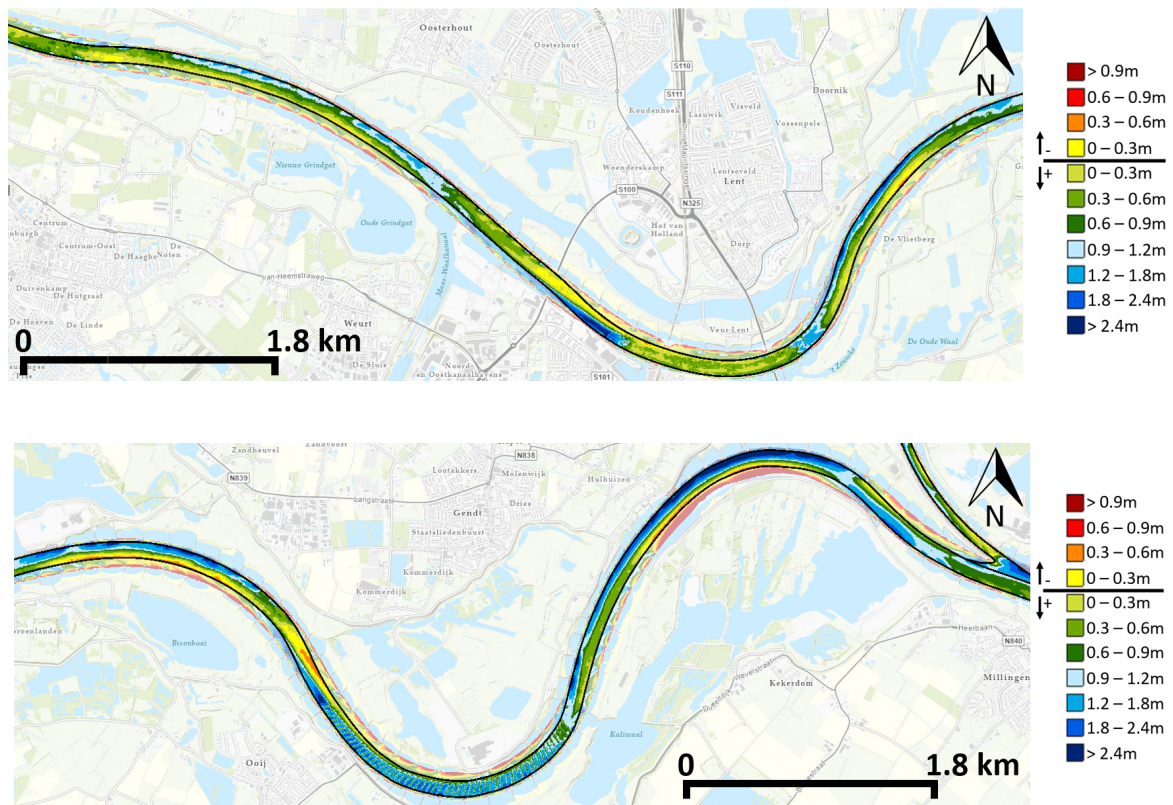

FIGURE 1.4: Water depth relative to the norm for ship navigation for the lower section (top) of the Boven-Waal, which ranges from rkm 880-892 in Figure 1.3, and for the upper section (bottom) of the Boven-Waal, which ranges from rkm 867-880 in Figure 1.3. The colorbars show the water depth relative to the norm for ship navigation. The colours yellow to red shows locations where the navigation depth is insufficient according to the norm. Green to blue colours show locations where the navigation depths are sufficient according to the norm. The current bottlenecks, the fixed layer at Nijmegen and the river bed groynes at Erlecom, can also be seen in the southern bends. The measurements in this map are based on a discharge of $1020 \text{ m}^3/\text{s}$ at Lobith (OLR). This map originates from WaterdiepteKaarten Rijntakken (maps.rijkswaterstaat.nl).

1.4 Research objective

Previous research in the Dutch Rhine delta has mainly focused on the implementation of a single type of river intervention (e.g., Liptiay, 2023; Pfeijffer, 2023; Rorink, 2022), which has always led to the conclusion that the researched river intervention cannot mitigate the ongoing bed degradation on its own. There is a lack of knowledge about the cumulative effects of individual interventions when river interventions are combined to counter the ongoing bed degradation in the long-term. This research aims to explore these cumulative effects when river interventions are combined to counter long-term bed degradation. This will be done in the Boven-Waal (Figure 1.2), as it is the river stretch with the largest bed degradation rate (Table 1.1). Simultaneously, the bed level in the Boven-Waal also has the largest effect on the discharge distribution at the first bifurcation point of the river Rhine in The Netherlands, the Pannerdensch Kop. Besides, it is of high economic importance that the Boven-Waal remains navigable in the future, as it is a vital connection between the port of Rotterdam and the hinterland. For these reasons, the Boven-Waal is also identified as a river stretch in which immediate bed level heightening is required (Ministerie van Infrastructuur en Waterstaat, 2023).

This research uses the two dimensional ‘Duurzame Vaardiepte Rijndelta’ (DVR) model, as it is required for accurate modelling of the dynamics in the meanders of the Boven-Waal. The research will start from relatively low effort changes that can be made to the Boven-Waal and its floodplains. First, it is investigated how the (re)construction of side-channels and lowering of summer dikes affect the Boven-Waal. The results of the simulations will mainly be assessed on the difference in summer bed height as compared to the reference situation, both on a larger and local scale. Additionally, there will be attention for the water levels/depths for different discharges and the division of discharge between the main channel and the floodplains. A good combination of interventions should ensure sufficient water depth for navigation. Sufficient being a navigation depth of 2.8 meter in the Waal during OLA and a width-averaged water depth of 4.0 meter during OLA (Rijkswaterstaat WVL, 2019). Besides, the situation unfolding at the Pannerdensch Kop as a result of the implemented river interventions will also be monitored accordingly.

Based on previous research, it is expected that this first set of measures will not reduce bed degradation in the Boven-Waal sufficiently, which is why a combination with other river interventions will be investigated. Combinations with other river interventions that are identified as good options for moving towards the IRM goals will be explored (Ouwerkerk et al., 2023). These additional river interventions will be groyne lowering and longitudinal training dams. This research could provide relevant insights into how a combination of river interventions may help in mitigating long-term bed degradation and its consequences for the Dutch Rhine delta. The focus is on which combination of interventions in the Boven-Waal is most effective and realistic for the mitigation of bed degradation. Concentrating on the Boven-Waal makes this research even more relevant, as reduction of bed degradation is most needed here (Ministerie van Infrastructuur en Waterstaat, 2023). Besides, it may be unveiled what river interventions might be effective or not in a river with large river bends. Most importantly, this research will add value to the already large knowledge base on river interventions. Hereby helping the movement towards a comprehensive plan for countering bed degradation in the Dutch Rhine delta.

1.5 Research questions

To achieve the research objective outlined in Section 1.4, a set of research questions is defined. By answering these research questions, the effect of combining different river interventions in the Boven-Waal on long-term bed degradation and its consequences can be quantified.

Main research question

'How can different combinations of river interventions in the Boven-Waal help the mitigation of ongoing long-term bed degradation and its consequences in the Dutch Rhine delta?'

Sub-questions

To answer the main research question presented above, three sub-questions are drawn up. These sub-questions outline the research and enable the fulfilment of the research objective.

1. What is the maximum achievable mitigation of bed degradation via low effort side channel (re)construction and summer dike lowering?
2. How does the mitigation of bed degradation change for different combinations of side channel (re)construction and summer dike lowering, groyne lowering and the implementation of longitudinal training dams?
3. What is the effect of the different combinations of river interventions on the consequences of bed degradation?

2 | Theoretical Background

This chapter presents the state-of-the-art knowledge on river interventions. First, the general effects of river interventions on the hydrodynamics and morphology of a river will be presented. Consequently, it will be explained what (re)construction of side-channels with summer dike lowering, longitudinal training dams and groyne lowering are, along with the current understanding on them.

2.1 The general effect of a river intervention on morphology

In order to model river interventions, an understanding of their effect on river morphology is required. River interventions can change the properties of a river in many different ways, examples being their cross-sectional area, bed roughness or sediment composition. In this section, the general effects over implementing river interventions in Boven-Waal will be discussed.

Since the Dutch Rhine branches are located in a delta with a mild bed slope (Frings et al., 2019), the flow in the branches is subcritical. Therefore, if an intervention were to be located in the Boven-Waal, not only the flow at the location of the intervention will change, but also the flow upstream will adapt to this downstream change. This upstream adaptation is called a backwater effect. The order of magnitude and reach of these backwater effects are dependent on several variables, such as bed slope, discharge, water depth and flow velocity. For example, when a river intervention essentially extracts discharge from the main channel of a river, the change in flow conditions induce an initial change in sedimentation and erosion patterns. Some parts of the river will experience sedimentation, while other parts will experience erosion. This initial change caused by the river intervention is largely governed by changes in flow velocity. Some parts of the river will have higher flow velocities, while other parts will have lower flow velocities due to the intervention. This difference causes velocity gradients between the different parts of the river. The parts of the river with a positive velocity gradient will have an increase in sediment transport capacity and thus experience erosion. Whereas a negative velocity gradient will cause a decrease in sediment transport capacity and thus sedimentation will occur. This process is well visualized in Figure 2.1.

It is important to note that this initial morphodynamic effect often diverges from the morphodynamic effect at equilibrium (de Vriend, 2015). In equilibrium, the river is fully adjusted to the change in flow conditions caused by the intervention. This situation is shown in the third longitudinal profile in Figure 2.1, where a higher bed level can be noticed upstream of the intervention and at the location of the intervention. So contrary to the initial response, the extraction of discharge from the main channel will actually increase upstream water levels at morphodynamic equilibrium. Besides, the erosion pit that was initially caused at the point where the discharge returns to its original amount again, propagates downstream. This erosion pit will diffuse and move downstream, outside of the domain covered by Figure 2.1. By doing so, this will cause more downstream erosion than initially present, until the morphodynamic equilibrium is reached after a long time (Figure 2.1).

The effect on the main channel river bed shown in Figure 2.1, is qualitatively speaking the same for the three studied interventions in this research. Both (re)construction of side channels with summer dike lowering and LTDs, as well as groyne lowering, essentially extract discharge from the main channel, at least for certain discharges. For the interventions to have the same qualitative effect as shown in Figure 2.1, they should influence the flow for the discharges that govern

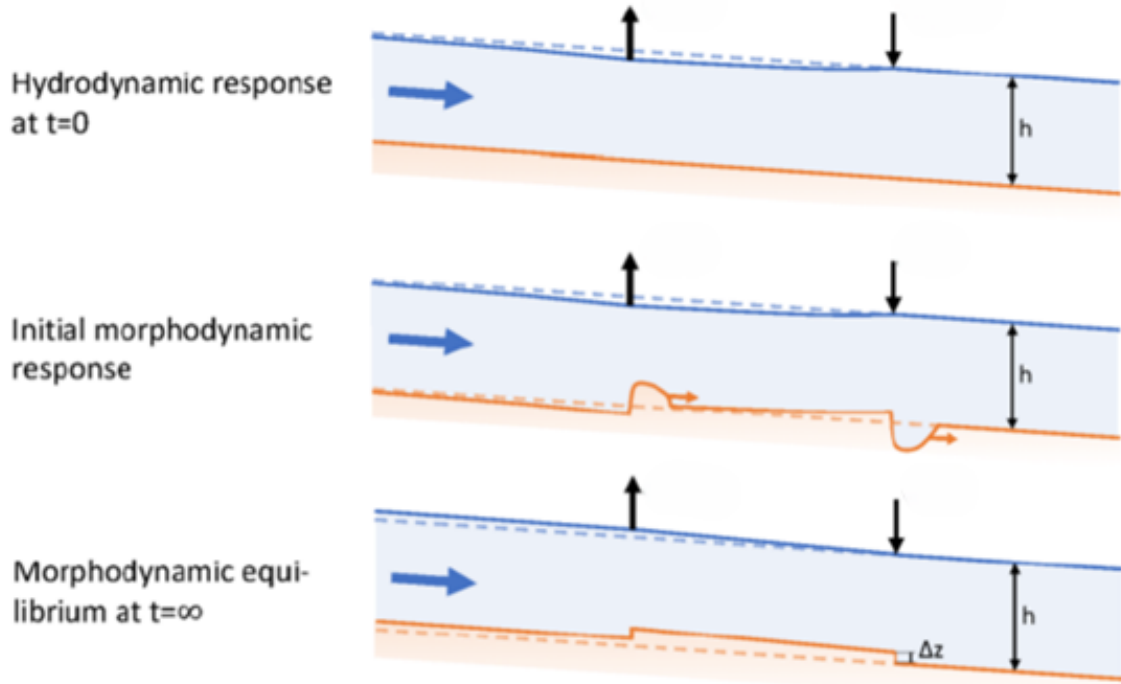

FIGURE 2.1: The initial and long-term longitudinal effect of an extraction of discharge from the main channel on its bed. The first bold black arrow shows the start of the extraction of discharge. The second arrow shows where the discharge returns to its original amount again. This image is adapted from Paarlberg & Schippers (2020).

morphology. When aiming to govern the morphology of a river, a focus on medium discharges is required, as they are present most of the time. Low discharges have a morphological impact that is simply too low, whereas high discharges do have a high morphological impact; however, those high discharges are too rare to count upon. Additionally, their morphological effects are smoothed again during lower discharges. Although it has been found that rapid succession of peak flows did have the ability to impact the morphological development at the Pannerdensche Kop (Chowdhury et al., 2023). Chowdhury et al. (2023) provided evidence for the peak flows of 1993, 1995 and 1998 influencing the bifurcation dynamics. Sudden sediment deposition was caused in the Pannerdensche Kanaal, which caused a gradual increase in the amount of discharge flowing into the Waal ever since. This again led to increasing erosion in the Waal and it might have been a possible trigger for the currently present bed degradation problem (Chowdhury et al., 2023). Such a phenomenon cannot be predicted by long-term morphological models, as it is unsure when such peak flows will happen on the long-term. Therefore, extreme high discharges will not be part of this research.

Lastly, it is relevant to consider that this described response of a river to an intervention is simplified. The system is regarded as one dimensional and the discharge is assumed to be constant over time. Reality is naturally three dimensional and there are also lateral differences in a river that are not addressed by Figure 2.1, especially in river bends. Besides, the river is subject to different discharges throughout the year. Of course, a representative upstream boundary condition can be put into a model to try and simulate the morphological development in a river. However, it is likely that the outcomes of a model are still quantitatively deviating from measurements in reality (Huthoff et al., 2010). This is exacerbated by the fact that there is no static equilibrium in real rivers, instead the morphology of a river is subject to morphological change on multiple scales (Arkesteijn et al., 2019; van Denderen et al., 2022). According to van Denderen et al. (2022), river interventions result in a bed level that fluctuates around an average change. This fluctuation is the

dynamic component of the equilibrium and it results from an imbalance between sediment supply and transport capacity, as a function of discharge (van Denderen et al., 2022). These considerations are important to keep in mind when modelling river morphology.

2.2 The specific effects of certain river interventions on morphology

Based on previous research, the following interventions were deemed promising for pursuing the goals of IRM in the Boven-Waal: (re)construction of side channels with summer dike lowering, longitudinal training dams and groyne lowering (Ouwerkerk et al., 2023; Pfeijffer, 2023; Rorink, 2022). In this paragraph, these three river interventions will be further explored by explaining the state-of-the-art knowledge on them.

2.2.1 (Re)construction of side channels with summer dike lowering

Side channels can be seen as a non-uniform lowering of the floodplain. They are connected to the main channel at two locations, which are the inflow and outflow of the side channel. In this research, the side channels will connect lower lying areas in the floodplains to the main channel, which requires less effort than excavating an entire side channel. Side channels extract discharge from the main channel, which reduces flow velocities in the main channel and thus cause sedimentation on the main channel bed over time (e.g., van Denderen et al., 2022). As the bed level of the main channel rises, in time this will cause more frequent activation of the floodplains. This sedimentation in the main channel will then also cause higher water levels during low discharges, which will simultaneously cause higher groundwater levels. Compared to uniform lowering of the floodplains, side channels create more room for nature development due to the more diverse landscape (Ouwerkerk et al., 2023). Besides, this research aims to start mitigation of bed degradation in the Boven-Waal by making use of low effort river interventions. Therefore, side channels combined with the lowering of summer dikes is selected over uniform lowering of the floodplains, as this requires excavation of the entire floodplain. Summer dikes keep rivers within certain boundaries until bankfull discharge. They represent the boundary between the summer bed of a river and its floodplains. By increasing bed levels in the main channel via (re)construction of side channels, while simultaneously lowering the summer dikes, more discharge will flow through the floodplains for lower discharges than in the original situation. If the floodplains were to be inundated for medium discharges, the ongoing bed degradation in the main channel might be mitigated (Ouwerkerk et al., 2023). Figure 2.2 shows an example of how this low effort starting package of interventions would look like.

The exact effects of side channels on sedimentation and erosion are dependent on several factors. One of these factors is the frequency of activation of a side channel, as this is related to the amount of aggradation in the main channel or the side channel itself. Activation meaning that water will start flowing from the main channel into the side channel. The more frequently a side channel is activated, the lower the aggradation rate will be in the side channel (van Denderen et al., 2019b). An additional advantage of frequent activation is that it is good for nature, as it increases the number of different fish species in the side channel (Geerling & van Kouwen, 2011). This frequent activation principle also has positive effects on the main channel. If a side channel is activated more frequently, it will induce more sedimentation in the main channel (Rorink, 2022; Welsch, 2021). If a side channel is only activated for higher discharges, additional erosion was found in the study of Welsch (2021). Rorink (2022) made the bed of modelled side-channels equal to the water level at its location at the start of a simulation, when a certain discharge was coming from Lobith. However, as the riverbed changed over the simulation years, the used Q-h relationship at the start was not true anymore during the simulation. Something similar happened in the study of Welsch (2021), where modelled side-channels in the Midden-Waal were activated for water levels higher than OLR ($1020 \text{ m}^3/\text{s}$), which was the intended activation height. Welsch (2021) determined

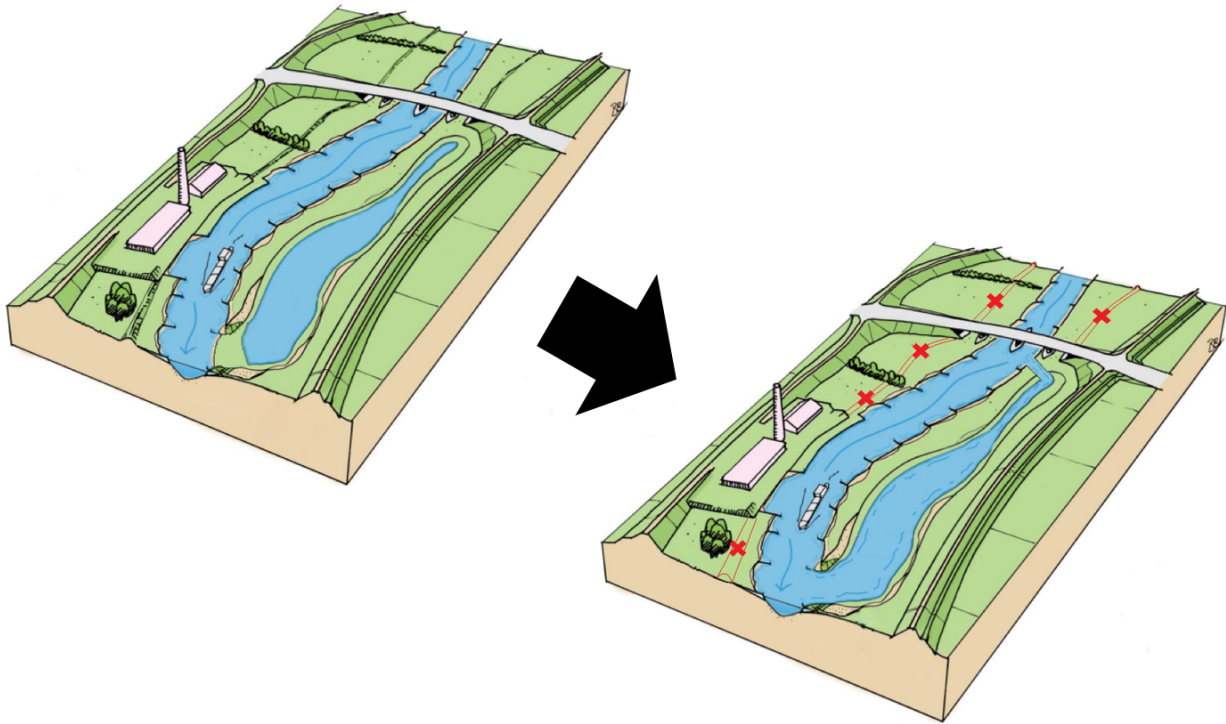

FIGURE 2.2: The left sketch shows an initial situation, where summer dikes are high and a lower lying area can be seen in the floodplain. The right sketch shows the situation after connection of the lower lying area in the floodplain to the main channel via implementation of side channels and the lowering/removal of summer dikes to the height of the surrounding area. This image is adapted from Ouwerkerk et al. (2023).

OLR with the model using the reference case, while the side-channels caused a backwater effect, leading to a different OLR upstream. This in turn led to the modelled side-channels to activate for different discharges than initially intended. Even though such interplay between the different side channels will happen in this research, it does not affect the outcome of the research, as in this research the elevation of the side channel bed is a given parameter, due to the interest into the maximum achievable mitigation of bed degradation via the connection of the lower lying areas in the floodplains with side channels. So in this research, the activation height of the side channels is equal to the elevation of the lower lying areas in the floodplains.

Another factor that influences the effects of side channels, is its location in space relative to its surroundings. For example, van Denderen et al. (2019b) mentions that the location of a side channel relative to other side channels may very well determine the amount of sediment supply it gets. Similarly, using a one-dimensional model, Oldenhof (2021) found that two sequential side channels may have different effects on the main channel depending on their location relative to each other. If there is a small overlap between two side channels, a sediment hump will form at the location of the overlap. Oppositely, if there is a small gap between two side channels a scour hole will form at the location of the gap. These findings were confirmed by Welsch (2021), using the two-dimensional DVR model. This study also gave insight into two dimensional effects that are necessary to assess the response in river bends. The connection of side channels to the main channel may induce secondary flow, which then creates local shallows over the width of the main channel (Welsch, 2021). Similarly, when side channels confluence in river bends, the created secondary flow may enhance erosion (Welsch, 2021) and direct more sediment towards the channel in the inner bend (van Denderen et al., 2019b). Thus, river bends have substantial influence on the resulting reaction of the main channel to side channels.

Lastly, the geometry of the side channel also influences its effect on the summer bed. Variables such as, the length and the width of the side channel (relative to the main channel), will cause different effects. Based on theory, a wider side channel will extract more discharge from the main channel, leading to more sedimentation in the main channel. Logically, longer side channels will induce effects over a longer distance. However, it seems that a sequence of shorter side channels influences the main channel with a similar magnitude as one long side channel (Rorink, 2022). Rorink (2022) expects that there will be more spatial fluctuations in the bed level of the main channel in the case of several shorter side channels.

2.2.2 Longitudinal training dams

Longitudinal training dams (LTDs) divide the main channel into two parallel channels. This division is either made by a stone dam or via a more natural method, in the form of a sand bar. An LTD makes the main channel more narrow, such that low water levels are increased. The created parallel channel is called a riparian or auxiliary channel. This riparian channel only starts to actively flow when the sill of the LTD is overflowed. The sill is a lowered part of the LTD that is located at the most upstream side of the LTD. By altering the height of the sill, it can be controlled for which discharges the the riparian channel is activated. Similarly, the height of the crest of the LTD can be altered to control the moment at which the LTD is fully overflowed.

LTDs replace the existing groynes in the inner bends of rivers. LTDs are implemented on the inner bend of rivers, because if they are implemented on the curvature crossover or bend apex, one channel will close due to rapid sedimentation (Czapiga et al., 2022). Besides, the bed level in the inner bend is generally shallower than the outer bend, which is required for the riparian channel that is created by the LTD. The riparian channel should only be activated for higher discharges, such that the LTD increases water levels during low discharge and decreases water levels during medium and high discharge (Ouwkerk et al., 2023). Another positive effect is the potential for diverse and stable habitats (Collas et al., 2018; Flores et al., 2022; Ouwkerk et al., 2023). LTDs offer more complex natural continuous littoral zones than the traditional groyne fields while maintaining the multifunctionality of the river (Flores et al., 2022).

For mentioned reasons, LTDs can be seen as a compromise between a nature-based solution and a hard engineering structure for navigability (de Ruijsscher et al., 2019). A LTD distinguishes itself from a classic side channel in the floodplains by its lateral exchange of water (e.g., Czapiga et al., 2022), while keeping the water within the boundaries of the main channel. Despite this difference, similar parameters as for side channels can be varied for LTDs, such as length, height of the LTD/sill or width. Intuitively, one would expect more sedimentation for lower sill/crest heights. However, research of Pfeijffer (2023) showed that lower sill/crest heights led to even more erosion, when looking at the Waal river as a whole. So, an LTD with a crest height of +2 meter OLR and a sill height of +0.5 meter OLR seems to function best. Figure 2.3 shows an example of a longitudinal training dam made of stone.

The downside is that LTDs require large alterations to a river. In addition, if an LTD is constructed with a stone dam between the two parallel channels, it could be an expensive river intervention. Depending on the origin of the rubble, a negative effect on the environment may also be present due to the caused emissions during transportation. Lastly, the LTD decreases the width of the navigation channel. This might be undesirable in a winding river section such as the Boven-Waal, as the bends already make the river more difficult to navigate.

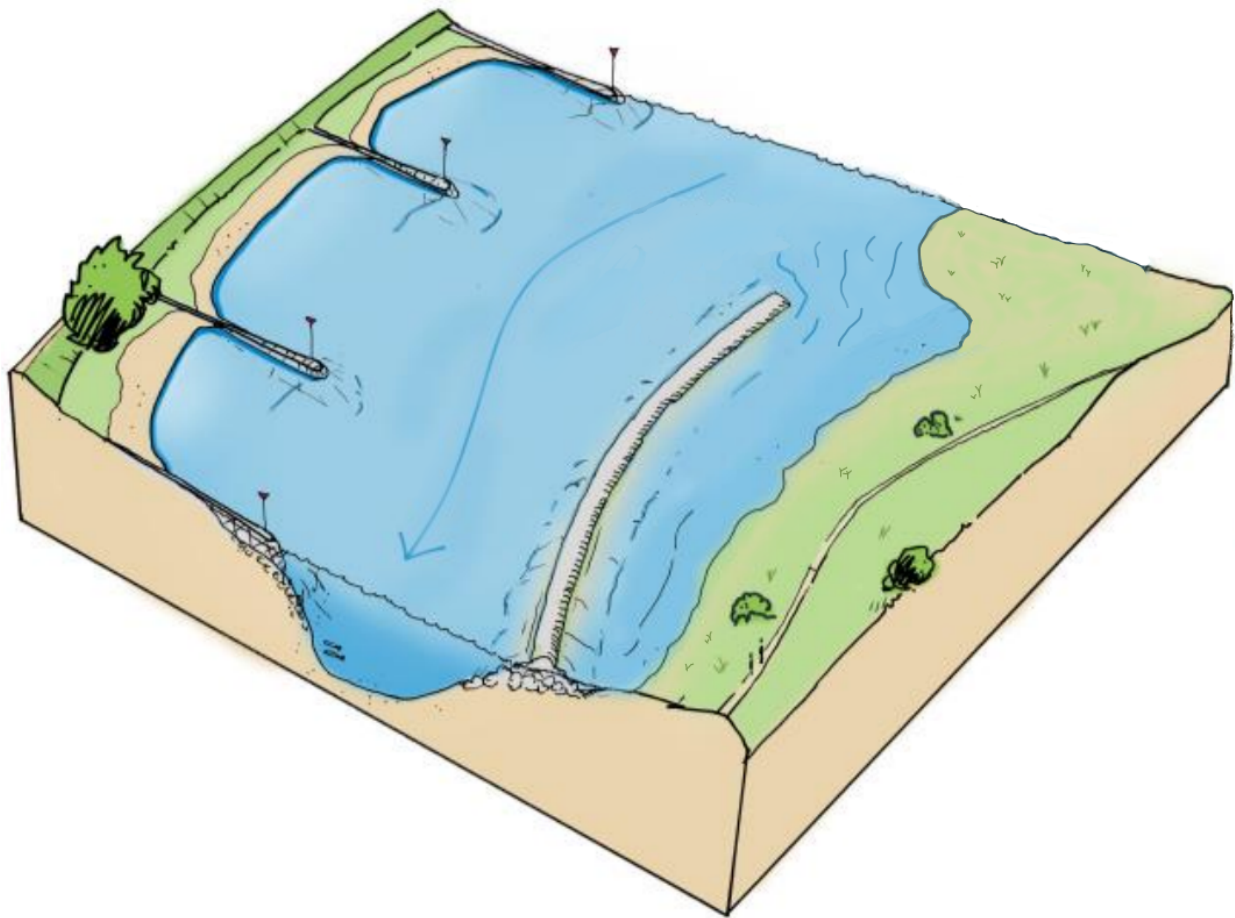

FIGURE 2.3: This sketch shows a longitudinal training dam (stone) that is already overflowing at its sill upstream. The crest of the longitudinal training dam is still above the water level and will only overflow for higher discharges. It replaced the groyne structures on the inner bend of the river, while the groyne structures in the outer bend remain. This image is adapted from Ouwerkerk et al. (2023).

Currently, there are no LTDs present in the Boven-Waal. They can only be found along a 10 kilometre stretch near Tiel, where they have been implemented as a pilot in 2015 (Eerden, 2022). In the short-term, the effects of the LTDs seem positive, as bed degradation is reduced locally. A net sedimentation was observed 5 years after the construction (Czapiga et al., 2022). However, using current models it is still not completely certain how large-scale implementation of LTDs along the Waal will function in the long-term, which can also be concluded from the research of Pfeijffer (2023).

2.2.3 Groyne lowering

Originally, groyne structures have been implemented with the aim to narrow the main channel, thereby keeping the flow away from the erodible banks and concentrating the flow in a smaller part of the channel. This way, a deep channel is achieved, which improved ship navigation (Yossef & de Vriend, 2010). Groyne structures have various negative side effects, such as erosion pits at the tips and a reduced ecological value in the riparian zones due to shipping waves (Collas et al., 2018). Besides, this deepening of the summer bed is currently an unwanted effect for IRM (Klijn et al., 2022), as it makes it more difficult to have sufficient water depth at the fixed layer at Nijmegen and the river bed groyne structures at Erlecom. As the bed level around these bottlenecks decreases, the fixed

layer and river bed groynes stay in place, which is why the bottlenecks are gradually becoming a larger bump relative to the surrounding river bed. So the water depth will be the lowest here, which is especially noticeable during low discharges, as the water depths are becoming critical then.

The lowering of groynes causes an increase in flow width during lower discharges, hereby reducing flow velocities in the main channel during these discharges. This decrease in flow velocity results in sedimentation in the main channel, over the length at which groynes are lowered. Compared to LTDs, the lowering of groynes can be a more straightforward solution, as the groynes are already in place. They merely have to be adapted. Lowering groynes will initially cause lower high water levels and in the long-term it will elevate the summer bed. However, water levels during lower discharges are also lowered, as the groynes are overflowed earlier when they are lowered. Groyne lowering has already been performed in the Waal, except for in the Boven-Waal (Ouwkerk et al., 2023). Figure 2.4 visualizes groyne lowering.

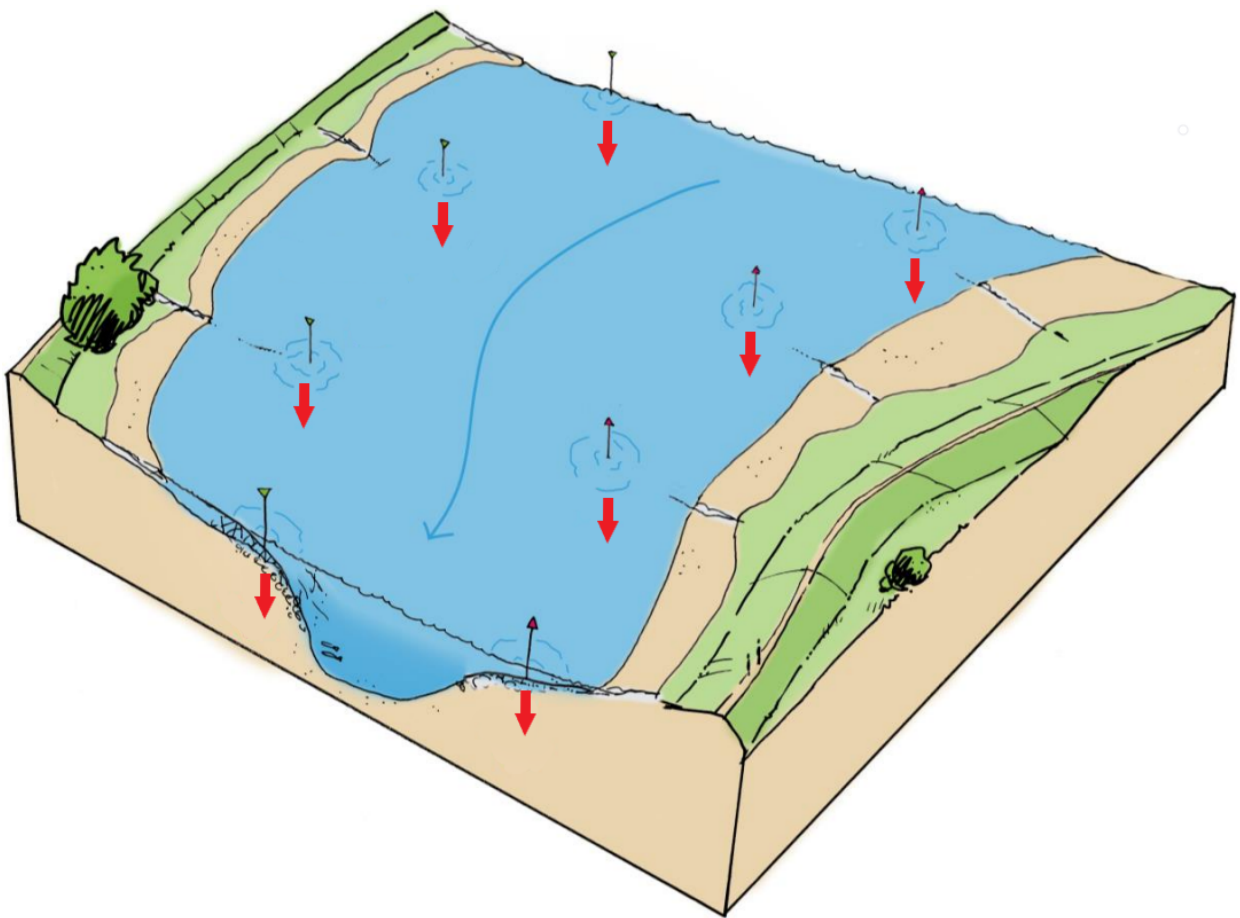

FIGURE 2.4: This sketch shows eight groynes that have been lowered on either side of the main channel. They are already overflowed in this sketch. This image is adapted from Ouwkerk et al. (2023).

3 | Methodology

This chapter introduces the model used in this research. Subsequently, the used domain, input and methods will be explained.

3.1 Model choice

This research will make use of the ‘Duurzame Vaardiepte Rijntakken’ (DVR) model (version `delft3d_4-rijn-j18-v0`). The DVR model was developed by Rijkswaterstaat and Deltares between 2006 and 2015 (Sloff et al., 2013), to enable assessment of different river interventions in the Dutch Rhine delta (van Vuren et al., 2015). The model is 2D as the calculations are depth-averaged. It contains innovative features that are helpful for this research, such as sediment transport over non-erodible layers, which is necessary for the correct modelling of the fixed layer at Nijmegen and the river bed groynes at Erlecom. The old version of the DVR model is outdated and certain processes are not functioning properly in the model (Sloff et al., 2023b). For these reasons, it was chosen to revise the model in 2023. At the start of this research, this revision of the DVR model was not yet finished. Therefore, it is important to note that the used version of the DVR model in this research is not yet the completely revised version of the DVR model. The used intermediate version performs considerably better than the old DVR model, which thus dates from 2015. However, the completely revised DVR model is expected to perform even better. The used version in this research, will from here on be referred to as the ‘intermediate’ version of the DVR model. Section 3.4 will compare the intermediate version of the DVR model with the old version of the DVR model.

The DVR model is applicable for the aims of this study, as it was originally designed as a prediction tool for assessing proposed constructive and sediment management measures in the Rhine Delta (van Vuren et al., 2015). Besides, it was developed to be used for long-term morphological assessment (Sloff, 2011). The model has been calibrated on the ability to match real life measurements. The most important aims being the ability to match the sediment transport and bed level height of Sloff (2019), to reproduce natural effects, such as lateral bend profiles and to correctly reproduce the trends in the discharge distribution at bifurcations. The discharge distribution at the Pannerdensche Kop is free in the DVR model.

The hydraulic roughness of the summer bed was the main calibration parameter and it was tweaked until a good fit with measurements as achieved. The hydraulic roughness of the riverbed in the intermediate version of the DVR model is in fact constant ($50 \text{ m}^{1/2}/\text{s}$). This implies that the development of bed forms does not influence the hydraulic roughness. However, this is compensated for by a constant ripple factor in the used sediment transport equation (section 3.3). This enabled better calculation of the spatial and temporal variation in sediment transport than with a hydraulic roughness that is dependent on bed forms (Sloff et al., 2023a).

The focus of the DVR model is to analyze the area on the level of the system. Therefore, the DVR model has less strict requirements for the accuracy of local effects. This does not imply that the local effects simulated by the DVR model are unreliable. It is only important to keep in mind for which processes the model was originally intended. This focus on morphology also causes a discrepancy between simulated and actual water levels, as the model was calibrated on good physical behaviour of the morphology. This discrepancy remains within a 30 centimeter dif-

ference over the complete model domain, when compared to Q/h relationships dating from 2018 (Sloff et al., 2023a). However, these differences are much smaller in large parts of the model domain.

The grid of the DVR model is curvilinear, which allows for accurate tracing of the river course. A side effect of a curvilinear grid is that the grid resolution is finer in the inner bends and coarser in the outer bends of the river. Grid cells in the inner bends are stretched out in the transverse direction. Due to similar reasons, the grid cells in the outer bends are very large, which limits the resolution with which river interventions can be implemented outside of the main channel.

Implementing river interventions in bends is dependent on the location at which the intervention is performed in the bend. Processes such as secondary flow will occur in the main channel, for example, when side channels are connected to the main channel in river bends (Welsch, 2021). Secondary flow is actually a 3D process, but in 2D it can already be accounted for more precisely, compared to a 1D model. In the DVR model, secondary flow is accounted for by extending the depth averaged shallow water equations (Section 3.3) with terms that capture the generation and adaptation of spiral motion intensity and the horizontal effective shear-stresses that originate from secondary flow. For mentioned reasons, the DVR model was deemed as the appropriate tool for this research.

3.2 Model domain

The model domain used in this research consists of nine sub-domains, which are visible in Figure 3.1. These sub-domains being the Boven-Waal (wl2a), Midden-Waal (wl2b), Beneden-Waal (wl2c), Pannerdensch kanaal (pan), the Boven-Rijn (br2), the German Niederrhein (br0), the Nederrijn (nr1a) and the IJssel (yac12 + yac3). The communication between these sub-domains takes place online along internal open boundaries, without the need for any additional boundary conditions here (Yossef et al., 2008). The fact that the complete model domain consists of several sub-domains is important for better modelling of bifurcations (Yossef et al., 2008), such as the Pannerdensch Kop, as it makes it easier to project the grid correctly. This domain requires four boundary conditions, one at the upstream boundary of the German Niederrhein (br0) and three at the downstream boundaries of the Beneden-Waal (wl2c), Nederrijn (nr1a) and the Lower-IJssel (Yac3). The upstream boundary is visible in Figure 3.2. The three downstream boundary conditions are Q/h relationships, which are shown for the Beneden-Waal, Nederrijn and Lower-IJssel respectively in Appendix A. For each of the nine upstream discharges of the hydrograph (Figure 3.2), a water level is prescribed at these downstream boundaries. These downstream boundary conditions have also been used during calibration of the DVR model and they are based on real-life measurements. Lateral inflow will be neglected in this research, as it is found to have a small effect in morphological simulations (Paarlberg & Van Lente, 2021).

3.3 Functioning of the model

The DVR model runs on the computational core of Delft3D-FLOW, which is combined with the Simulation Management Tool (SMT). The SMT is used to optimise long-term computations (Yossef et al., 2008). It makes smart use of the steady steps present in the upstream hydrograph (Figure 3.2). Using morphological scaling factors, one year of morphological simulation corresponds to sixteen steady discharge steps with different durations (Figure 3.2). Higher discharge levels get lower morphological scaling factors, while lower discharge levels get higher morphological scaling factors. This is done to prevent errors, as high discharges will have higher sediment transport rates and vice versa (Pfeijffer, 2023). The lowest discharges of $1020 \text{ m}^3/\text{s}$ and $1294 \text{ m}^3/\text{s}$ have a

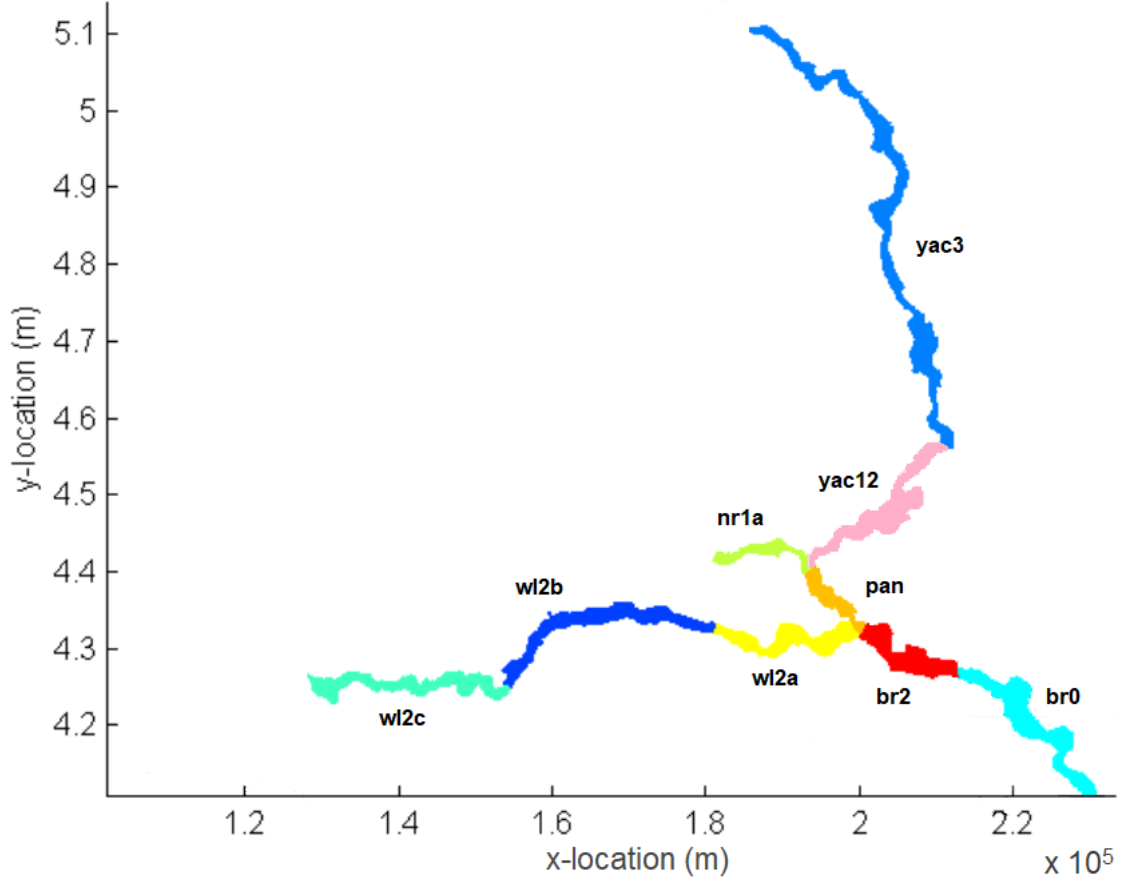

FIGURE 3.1: The model domain of the DVR model. Each sub-domain is highlighted in a different colour. This figure is adapted from Ottevanger et al. (2015).

morphological scaling factor of 1440. The higher discharges of $4353 \text{ m}^3/\text{s}$, $5506 \text{ m}^3/\text{s}$ and $7009 \text{ m}^3/\text{s}$ have a morphological scaling factor of 120. The medium discharges of $1543 \text{ m}^3/\text{s}$, $1954 \text{ m}^3/\text{s}$, $2601 \text{ m}^3/\text{s}$ and $3384 \text{ m}^3/\text{s}$ have morphological scaling factors of 720, 720, 240 and 240 respectively.

So, there are only nine unique discharges in this upstream hydrograph. Thus during the simulation, the DVR model will encounter these nine unique discharges more often. The SMT makes handy use of this by storing the corresponding hydrodynamic results of the most recent step of each upstream discharge in a database. For example, when a step starts in which an upstream steady discharge of $2601 \text{ m}^3/\text{s}$ is present, the DVR model will retrieve the flow fields from the database that belong to the last time that an upstream discharge of $2601 \text{ m}^3/\text{s}$ was encountered. The DVR model creates a restart file by combining the end-morphological condition of the last step and the stored hydrodynamic conditions belonging to the last time an upstream discharge of $2601 \text{ m}^3/\text{s}$ was simulated. Morphology will have changed a bit since the last time that an upstream discharge of $2601 \text{ m}^3/\text{s}$ was simulated. Therefore, the model spins-up hydraulically again to adapt the remembered hydrodynamic conditions to the current morphology. These flow fields require less hydraulic spin-up time to become stable, thereby reducing the computational time of the simulation.

Delft3D-FLOW solves the unsteady shallow water equations in two dimensions (2DH, depth-averaged). The horizontal length and time scales are significantly larger than the vertical scales of the Rhine branches. Therefore, using a depth-averaged model is valid. The hydrodynamics are calculated with the depth-averaged unsteady shallow water equations, which are shown in Equation 3.1 and 3.2.

$$\frac{\partial u}{\partial t} + u \frac{\partial u}{\partial x} + v \frac{\partial u}{\partial y} + g \frac{\partial z_w}{\partial x} = -g \frac{u\sqrt{u^2 + v^2}}{hC^2} \quad (3.1)$$

$$\frac{\partial v}{\partial t} + u \frac{\partial v}{\partial x} + v \frac{\partial v}{\partial y} + g \frac{\partial z_w}{\partial y} = -g \frac{v\sqrt{u^2 + v^2}}{hC^2} \quad (3.2)$$

In equation 3.1 and 3.2, u [m/s] is the depth-averaged velocity in the longitudinal direction, which is denoted as x [m]. v [m/s] is the depth-averaged velocity in the transverse direction, which is denoted as y [m]. t [s] is time, g [m/s²] is the gravitational acceleration, z_w [m] is the water level, h [m] is the water depth and C [m^{1/2}/s] is the Chézy roughness coefficient.

This hydrodynamic module is coupled with a morphological module. This morphological module calculates sediment transport and consequently, the development of the bed is determined. The sediment in the DVR model is divided over eleven sediment fractions. The smallest sediment fraction ranges from $6.3 \cdot 10^{-5}$ to $2.5 \cdot 10^{-4}$ meter, while the largest sediment fraction ranges from 0.063 to 0.125 meter. In the DVR model, it was chosen to use the Meyer-Peter-Müller (MPM) equation for the calculation of both bed and suspended load sediment transport (Meyer-Peter & Müller, 1948), even though, the MPM equation was originally developed for coarse bed load. However, in the DVR model, the MPM equation was calibrated for every sub-domain, as every sub-domain has its own trends. The transport gradients and yearly sediment transport (1999-2018) of each sub-domain were used for this calibration. It has been considered to use other equations for sediment transport, such as a combination of the MPM with the Engelund-Hansen equation (Sloff et al., 2023a), however, solely using the MPM for both bed load and suspended load led to the most accurate simulation of current morphological trends. Therefore, a per sub-domain calibrated Meyer-Peter-Müller equation was used to calculate sediment transport in the DVR model. So, suspended load is only accounted for in the DVR model by the multiplication of a calibration factor (per sub-domain) with the bed load. Equation 3.3 shows the general Meyer-Peter-Müller equation.

$$S = \alpha B D^{3/2} \sqrt{g \Delta} \left(\frac{\mu u^2}{C^2 \Delta D} - \xi \theta_{cr} \right)^{3/2} \quad (3.3)$$

In this equation, α [-] is a calibration coefficient, B [m] is the alluvial width of the river, D [m] is the grain diameter, Δ [-] is the relative density, μ [-] is the ripple factor ($=1$), u [m/s] is the depth-averaged flow velocity, ξ [-] is the hiding and exposure factor, which contains a correction formulated by Parker et al. (1982) and θ_{cr} [-] is the critical Shields stress.

As a reaction to the calculated sediment transport, the morphological module calculates the bed development. This bed development is dependent on the difference between the amount of sediment entering and leaving a grid cell. The Exner equation (Equation 3.4) is used to calculate this development of the bed.

$$(1 - \epsilon) \frac{\partial z_b}{\partial t} + \nabla q_s = 0 \quad (3.4)$$

In equation 3.4, ϵ [-] is the bed porosity, z_b [m] is the bed level and ∇q_s is the divergence of the the bed-material load sediment flux (q_s [m^2/s]) per unit width.

3.4 Difference between the old and intermediate version of the DVR model

The old version of the DVR model has been used extensively in preceding morphological studies (e.g. Becker, 2021; Pfeijffer, 2023; Welsch, 2021). The intermediate version of the DVR model (delft3d_4-rijn-j18-v0), includes some improvements upon the old version, but is certainly not the end-product yet. In this section, the differences between the old version and the intermediate version of the DVR model will be outlined.

One of the important changes is the changed upstream boundary condition, which is the steady step discharge hydrograph. Figure 3.2 compares the hydrograph of the old DVR model to the hydrograph present in the intermediate version of the DVR model. Both hydrographs were made for calibration purposes. So they were both made to fit past discharges. The old hydrograph was calibrated on the period from 1971 to 2009, whereas the new hydrograph is calibrated on the period from 2011 to 2020. The steady step hydrographs are obtained via a transformation of the discharges in the calibration period to a probability density function, which is normalized to a length of 365 days. In order to reduce computational time (Section 3.3), this probability density function is discretized into a sequence of 9 steady discharge steps. From Figure 3.2, it can be noticed that the hydrograph of the intermediate version has overall slightly lower discharges than the hydrograph used in the old DVR model.

Some other important changes were also made in the intermediate version of the DVR model. The fixed layer at Nijmegen (Figure 1.3, rkm 883 - 886) was non erodible over the whole river width in the old version of the DVR model. In reality, only the outer bend is fixed and the inner bend is free to erode. This is solved in the intermediate version of the DVR model, as the inner bend can now actually be eroded. At the height of this fixed layer, an important change to the grid was also made. The side channel (Spiegelwaal) at Nijmegen (Figure 1.3, rkm 882.5 - 886.5) has been refined by a factor of two. So every cell in the Spiegelwaal in the old version of the DVR model is split into two cells in the intermediate version of the DVR model.

Another considerable change is that the intermediate version of the DVR model uses more sediment fractions over the whole length of the model. The old version merely used these sediment fractions in the most upstream river branches, the other river branches used a uniform sediment composition. In the intermediate version, each sub-domain consists of seven sediment layers, each consisting of eleven sediment fractions. The bed composition is based on measurements dating from 2020. Samples have been taken every 500 meter on the central axis of the rivers and every 1000 meter to the left and right of the central axis. These measurements showed that there seems to be a large cross-sectional difference in the percentiles of grain diameters, which is likely caused by ship navigation, for which the DVR model does not account for (Sloff et al., 2023a). Therefore, at every 1000 meter where there are three cross-sectional samples available, it was chosen to mix these three samples (Sloff et al., 2023a). Similarly, a large difference in the bed composition was also present

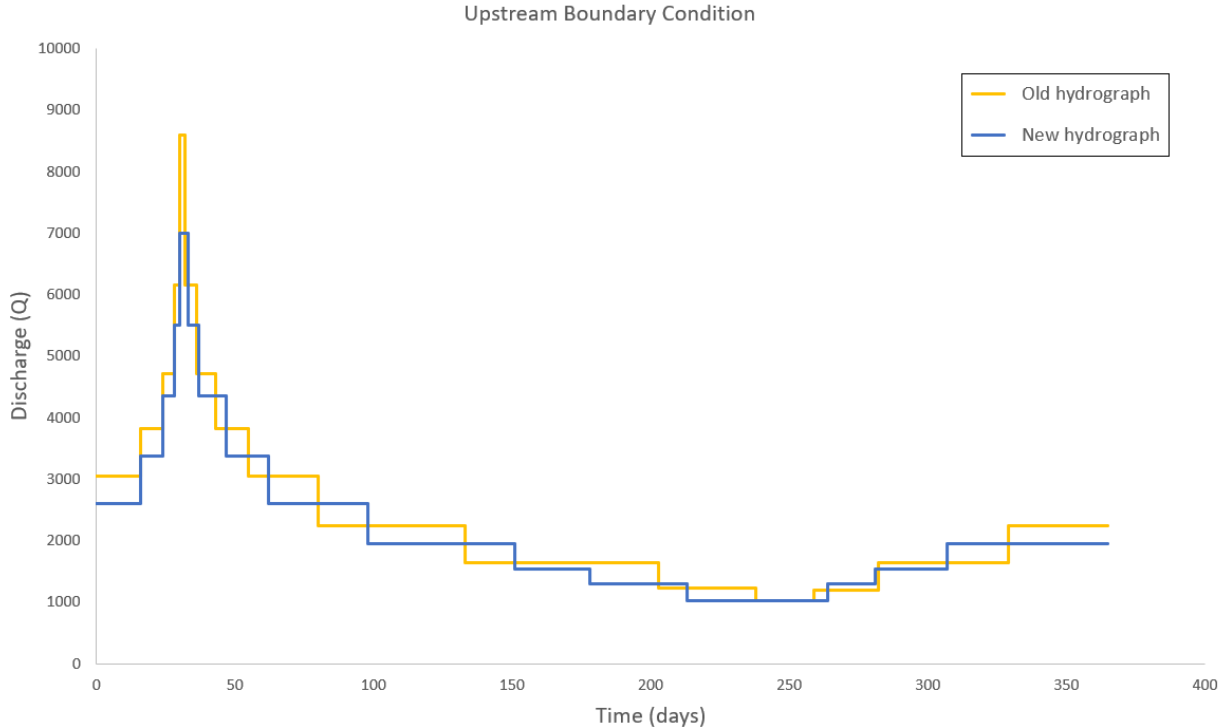

FIGURE 3.2: The hydrographs used at the upstream boundary. The yellow hydrograph was used in the old version of the DVR model. The blue hydrograph is used in the intermediate version of the DVR model.

in the longitudinal direction. These differences are likely caused by bed forms and measurements inaccuracies. To solve this, Sloff et al. (2023a) used a moving average of 10 kilometers in the longitudinal direction and omitted unrepresentative samples. Older measurements have been used for the German Niederrhein, as the aforementioned recent measurements were not performed here.

Changes have also been made to the implementation of the active layer concept in the model. In the old DVR model, the active layer was dependent on the water depth (e.g., Becker, 2021; Pfeijffer, 2023). The active layer is the part of the riverbed that is subject to sedimentation and erosion processes. The sediment within the active layer is considered uniformly mixed. In the intermediate version of the model, the active layer is fixed at 1 meter. This constant active layer reduces the complexity of the model without losing quality, as there is plenty of uncertainty about the depth of the active layer and how it varies per river stretch. Lastly, the old version also imposed bed erosion at the upstream boundary, while a stabilized bed level at the upstream boundary fits current trends better. So no more erosion is imposed from the upstream boundary.

3.5 Morphological spin-up

The initial bed composition determines the gradient in sediment transport to a large extent. Consequently, it also determines the initial morphological reaction of the riverbed, as these two processes are connected to each other. These initial effects that are induced by the model, causes bed level variations that disappear after approximately 2 years of simulation. However, bed level variations present due to an initial reaction to the fixed layer at Nijmegen and river bed groynes at Erlecom, persist even after 5 to 10 years, as these initial reactions in the form of sedimentation and erosion patterns advect and diffuse downstream (Appendix C). It is important to keep this in mind dur-

ing the analysis of the model output, as this is a model induced effect and it is not present in reality.

In this research, the model is morphologically spun up for two years. During this simulation, the hydrograph presented in Figure 3.2 is imposed at the upstream boundary. Before each steady discharge step, the model is given a day to spin up hydraulics, which is more than enough (Appendix B). During this period, no morphological change can happen. Apart from these hydraulic-spin ups, the river bed and its composition are allowed to develop freely. When taking into account the duration and the morphological scaling factor of each steady discharge step, this period in which the bed level and sediment composition can develop freely in the morphological spin-up is equivalent to two years of morphological development. The bed composition and bed levels at the end of this two year period of morphological development are imposed on the model at the start of each of the performed simulations in this research. Appendix C shows the effect of this morphological spin-up on the river bed. Here, a reference simulation of 20 years is performed with and without this morphological spin-up. It can be concluded that the morphological spin-up helped reduce the initial large fluctuations that are caused by the fact that it is a model, which always needs some spin-up in order to become more stable. However, the reaction of the DVR model to the fixed layer at Nijmegen and the river bed groynes at Erlecom could not be excluded completely. Nevertheless, relative differences between simulations can still be compared, even though the bed degradation in the Boven-Waal is underestimated.

3.6 Performed simulations

In order to answer the research questions, several simulations need to be performed with the intermediate version of the DVR model. Table 3.1 shows the performed simulations in this research. Simulations are labeled with a subscript, which shows which interventions are included in them. Simulations with the subscript 'SC' include low effort side channel (re)construction and summer dike lowering. While simulations with the subscript 'GL' include groyne lowering and similarly, simulations with subscript 'LTD' include longitudinal training dams.

TABLE 3.1: The performed model simulations for this research and the river interventions they include.

Simulation	Description
Sim _{REF}	Reference run
Sim _{SC}	Side channels + summer dike lowering
Sim _{SC-GL}	Side channels + summer dike lowering + groyne lowering
Sim _{SC-GL-LTD}	Side channels + summer dike lowering + groyne lowering + LTDs
Sim _{SC-LTD}	Side channels + summer dike lowering + LTDs
Sim _{GL-LTD}	Groyne lowering + LTDs

First a reference run (Sim_{REF}) is simulated. This is the simulation in which no action is undertaken to counter the bed degradation. This 20 year reference simulation enables comparison with the scenarios that include the different river interventions. These simulations are designed by combining literature with expert knowledge. The simulations will consist of different combinations of river interventions, which will uncover the effectiveness of the different combinations in mitigating the bed degradation and its consequences in the Boven-Waal. Figure 3.3 shows a diagram with the performed simulations in this research. Via cross comparison between these different simulations the added value in mitigating bed degradation and its consequences of the different river interventions is explored.

Attachment of lower lying areas in the floodplains to the main channel via side channels and the lowering of summer dikes is seen as a good starting point for mitigating bed degradation (Sim_{SC}), as large-scale river widening can be achieved with relatively low effort. This simulation also provides the information needed to answer research question 1. Sim_{SC-GL} , $Sim_{SC-GL-LTD}$ and Sim_{SC-LTD} add onto the effect induced by the implemented side channels and summer dike lowering by different combinations of LTDs and groyne lowering. Sim_{GL-LTD} is there to check whether the side channels and summer dike lowering have added value upon a sole combination of groyne lowering and LTDs. Comparison between these simulations will show the cumulative effects of the different combinations of (re)construction of side channels with summer dike lowering, LTDs and groyne lowering, which will provide an answer to research question 2. By looking at the effect of the different combinations of river interventions on navigability, flood protection and fresh water availability, an answer to research question 3 can be formulated. When the three research questions have been answered, it is known how different combinations of river interventions impact the mitigation of ongoing long-term bed degradation and its consequences in the Dutch Rhine delta. Thus an answer to the main question can be formulated.

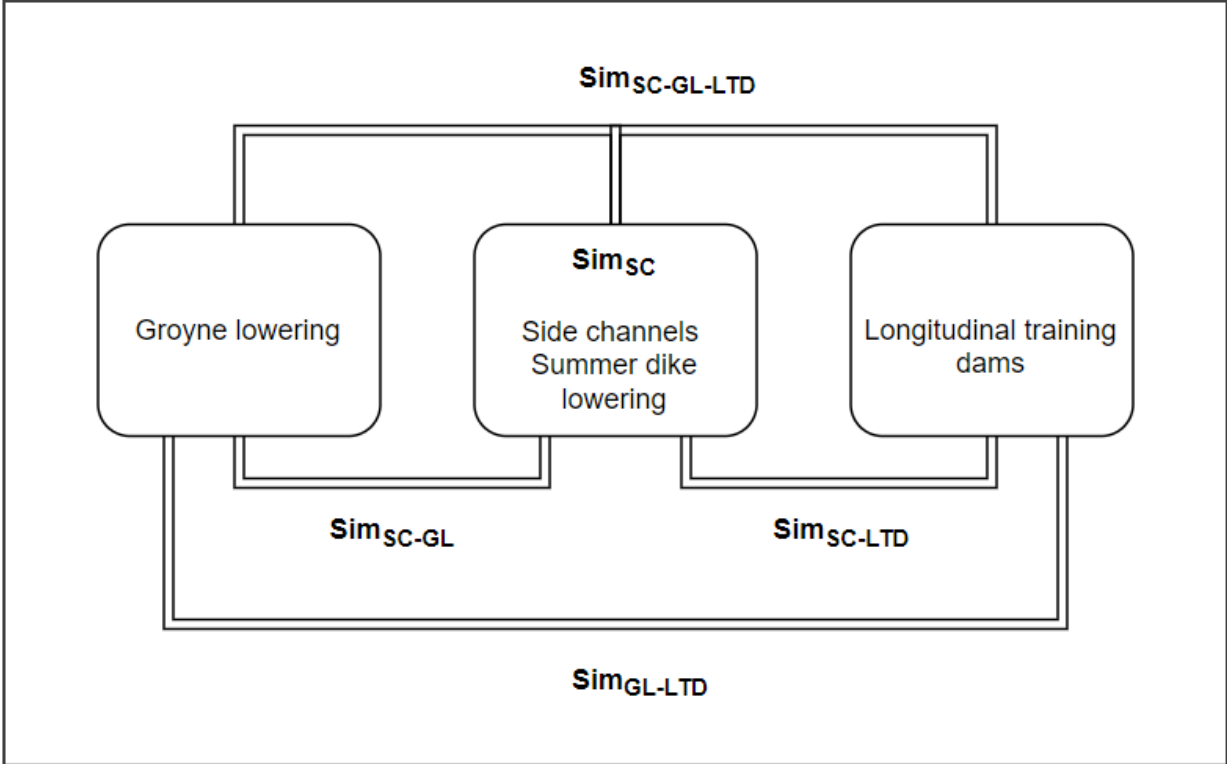

FIGURE 3.3: Diagram that shows the performed simulations and the river interventions they comprise.

In order to schematize the proposed river interventions for the different simulations, the input files of the DVR model had to be adjusted. The input files of the DVR model are Delft3D input files. They comprise text files that represent different characteristics of the grid cells, such as the roughness in the U and V direction, bathymetry, the location and height of weirs, sediment layer thickness, sediment fractions etc. By changing these characteristics, the river interventions can be schematized in the model input. The following sections will shortly address how this was done for each river intervention. The label belonging to the described intervention is shown behind the header of each section, making clear what has exactly be included in each simulation visible in Table 3.1 and Figure 3.3. A more elaborate explanation of how this was done exactly can be found in Appendix D.

3.6.1 (Re)construction of side channels with summer dike lowering (*sc*)

(Re)construction of side channels

When looking at the floodplains of the Boven-Waal, there are several lower lying areas in the floodplains that can be connected to the main channel via side channels (Figure 3.4). Besides, there are also already two side channels (Klompewaard and Spiegelwaal) present that can be deepened to induce more sedimentation in the main channel. In the past, Rijkswaterstaat allowed the creation of side channels, but they had to induce as little sedimentation in the main channel as possible. This was enforced as Rijkswaterstaat believed that rivers should be maintained in their current state. Over the past years, the vision of Rijkswaterstaat shifted towards a more functional approach. Meaning that the river should not necessarily be maintained in its current state, but that loss of function(s) should be prevented.

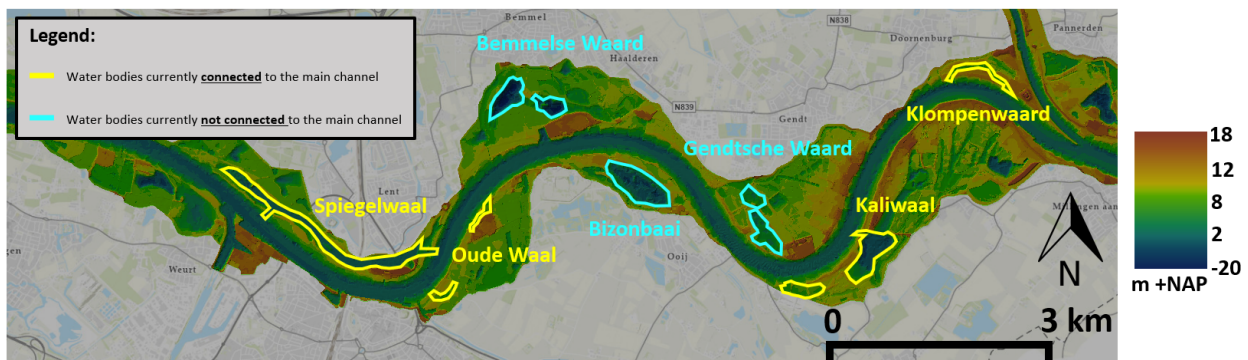

FIGURE 3.4: Currently present lower lying areas in the floodplains of the Boven-Waal (rkm 867-892 in Figure 1.3).

In order to achieve the maximum mitigation of bed degradation via low effort side channel (re)construction, the lower lying areas present in the floodplains (Figure 3.4) will be connected to the main channel at their highest elevation. This way, these lower lying areas will not have to be adapted themselves. If this would have been done, it would not make for a relatively simple solution anymore, as making the side channels deeper than the highest elevation of the lower lying areas will require excavation of the lower lying areas, which is unwanted for this river intervention. Figure 3.5 shows exactly where the lower lying areas have been connected to the main channel via side channels in the model input. It can be noticed that some compromises had to be made due to the coarse grid towards the outside of the floodplains. For example, the Kaliwaal and Bizonbaai could simply be connected to the main channel via two simple side channels, whereas the lower lying areas in the Gendtsche Waard and Bemmelse Waard had to be implemented differently, as their characteristics were not accurately projected on the coarse grid.

Table 3.2 shows the elevation at which the lower lying areas in the floodplains are connected to the main channel. It was chosen to keep the Spiegelwaal (Figure 3.4) as it is currently schematized in the DVR model. Its inflow is specified as a source and sink relationship, while the inflow of the other side channels is free to develop. Besides, it seems that the weirs and bathymetry have also been tweaked at the inflow of the Spiegelwaal, in order to achieve realistic morphological development with the DVR model. In addition, the present culverts at the inflow of the Spiegelwaal are in reality designed to extract only a small portion of the flow in order to keep the water in the Spiegelwaal flowing and hereby preventing eutrophication. If the Spiegelwaal was to extract more discharge from the main channel, it would surely aggravate the already critical navigation problems at the fixed layer at Nijmegen during low discharges.

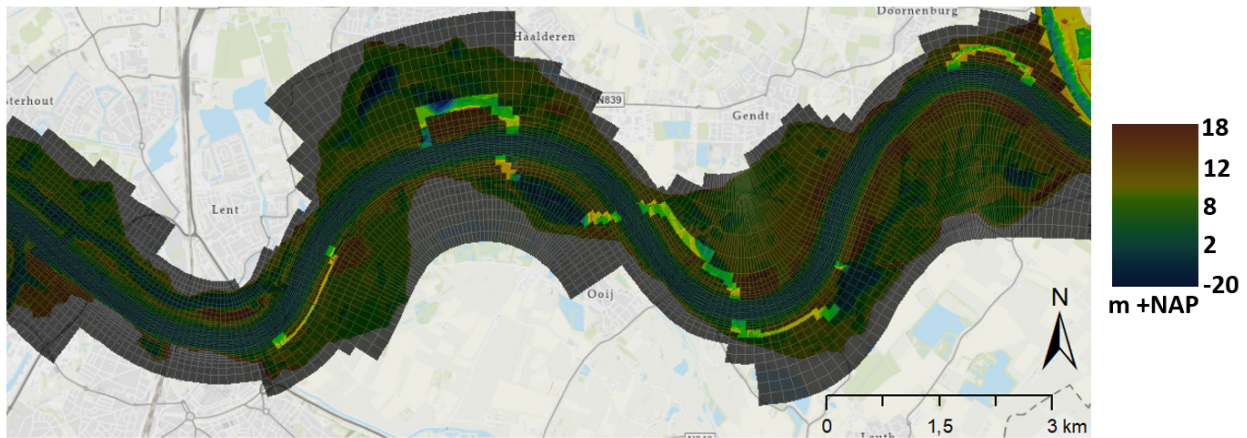

FIGURE 3.5: The grid of the DVR model in the Boven-Waal (rkm 868-887 in Figure 1.3). The grid cells of which characteristics have been adapted in order to connect the lower lying areas in the floodplains to the main channel are transparent. Black grid cells are unchanged.

TABLE 3.2: The elevation at which the side channels are connected to the main channel.

Side channel	Elevation (m +NAP)
Klompenwaard	7.4
Kaliwaal	4.6
Gendtsche Waard	5.6
Bizonbaai	5.0
Bemmelse Waard	7.5
Oude Waal	6.0

Next to the change in bathymetry (Table 3.2), other input files need to be adapted to accurately implement the described river intervention. The roughness of the highlighted grid cells in Figure 3.5 is changed to a Nikuradse roughness height of 0.2 meter, for which Welsch (2021) found good results when modelling side channels. Additionally, all present weirs within the highlighted grid cells in Figure 3.5 have been removed. A weir is a fixed non-movable construction that generates energy losses due to constriction of the flow. Weirs are commonly used in hydraulic models to model sudden changes in depth (e.g. LTD crests, groynes or summer dikes).

Summer dike lowering

Figure 3.6 shows the currently present summer dikes and the discharges measured at Lobith that are required to overflow them. It can be seen that most of the surface area of the floodplains has a lower elevation than the summer dikes and that this surface area can only be inundated if the water level is high enough to overflow the summer dikes. Currently, extreme discharges are currently necessary for the summer dikes to be overflowed (Figure 3.6). The marked summer dikes in Figure 3.6 are lowered to the elevation of their surroundings, such that the floodplains are inundated at lower discharges. This lowering of the summer dikes is achieved by removing the weirs that represent summer dikes from the input files (Figure 3.7). Together with the connection of lower lying areas in the floodplains to the main channel via side channels, these river interventions make for a low effort starting package of interventions to mitigate bed degradation.

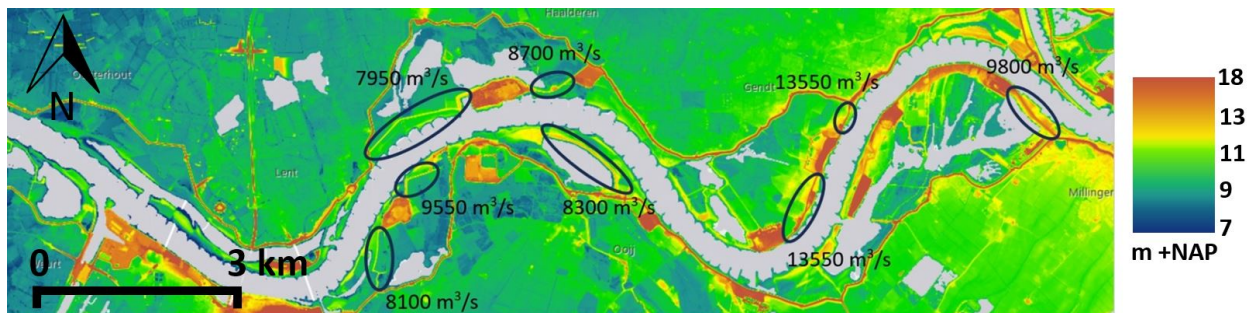

FIGURE 3.6: Elevation map of the study area (rkm 867-888 in Figure 1.3). The existing summer dikes are visible within the black ovals. They are considerably higher than the rest of the surface of the floodplains. The approximate discharge at Lobith originally needed to overflow each summer dike is shown next to each summer dike. This map is adapted from AHN (ahn.nl).

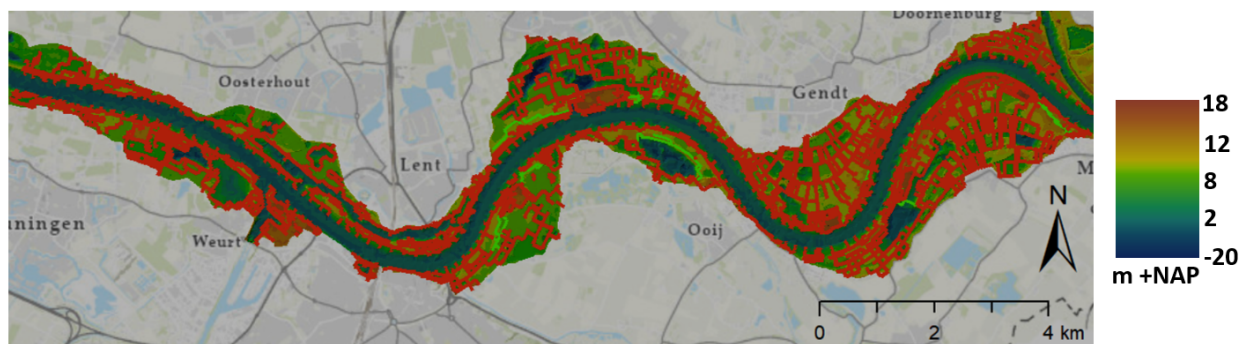

FIGURE 3.7: The present weirs in the model input of the Boven-Waal (rkm 868-892 in Figure 1.3). The currently present summer dikes in the Boven-Waal, are schematized as weirs in the model input. The weirs marked in green represent the summer dikes and are removed. The weirs marked in red are unchanged.

3.6.2 Longitudinal training dams (*LTD*)

An LTD should be located on the inner bend of the main channel (Section 2.2.2). Therefore, it is straightforward where the LTDs should ideally be located in the Boven-Waal. Previous studies largely use the same locations for LTDs in the Boven-Waal (e.g., Huthoff et al., 2015; Pfeijffer, 2023). The same design is used in this research and it is called 'Gloobaal Ontwerp Langsdammen', which is specified by Huthoff et al. (2015). Figure 3.8 shows the used locations for LTDs in the Boven-Waal in this research. It was chosen to use a crest height of +2 meter OLR, a sill height

of +0.5 meter OLR and a riparian channel width of 100 meter for the LTDs. This leads to a narrowing of the main channel by approximately 20 meter, compared to the initial groyne tips. This corresponds to the design used by Huthoff et al. (2015) and Pfeijffer (2023). OLR 2022, as described by van Putten & Vrijaldenhoven (2022) will be used to determine these heights. It has been taken into consideration to use the model output of the reference run for the determination of OLR, where a water level belonging to a discharge of $1020 \text{ m}^3/\text{s}$ (OLR) in the model could be derived along the Boven-Waal. This was not done, as the model is known to have inaccurate water levels. So instead, river interventions are designed relative to OLR 2022.

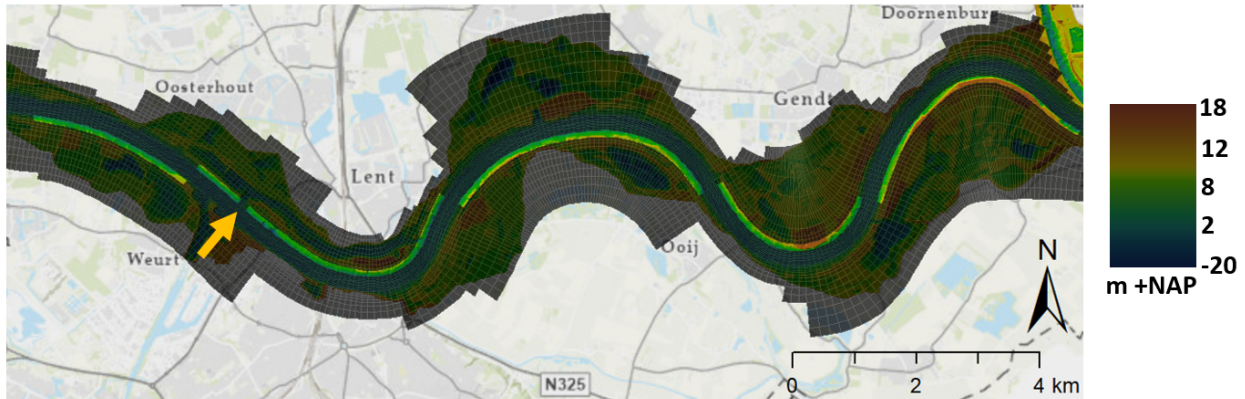

FIGURE 3.8: The grid of the DVR model in the Boven-Waal (rkm 868-892 in Figure 1.3). The grid cells of which characteristics have been adapted in order to schematize LTDs are transparent. Black grid cells are unchanged. The yellow arrow indicates the outflow of the Spiegelwaal, where the LTD is interrupted by default in 'Globaal Ontwerp Langsdammen'.

Similar to the implementation of the side channels that connect lower lying areas to the main channel, all present weirs within the highlighted grid cells in Figure 3.8 have been removed. Weirs with a height corresponding to +2 meter OLR 2022 have been implemented on the outside of the grid cell, which represent the LTD crest. Similarly, weirs with a height of +0.5 OLR have been implemented on the outside of the grid cells at the start of an LTD, which represent the sill. The roughness of the riparian channels was set to a Nikuradse roughness height of 0.2 meter, while the Nikuradse roughness height of the LTD crest was set to 0.4 meter. Lastly, the LTD crests and their riparian channels were designed to not contain sediment at the start of the simulation. This ensures that the LTD itself will not erode during the simulation, as the model can only erode what is deposited during the simulation, if there is no initial sediment layer present. Besides, riparian/side channels are generally known to fill up with sediment (van Denderen et al., 2019b). Although Flores et al. (2022) found that erosion does occur in riparian channels of LTDs, but only on the outside towards the littoral zones, where erosion mostly happens in the form of bank erosion. No sediment layer is present in the floodplains and thus no bank erosion can happen during the simulations.

When combining LTDs with side channels, conflicts may happen if the side channel flows out of or into the riparian channel of the LTD. If this happens in a simulation in this research, the LTD will be interrupted at these locations. This looks similar to the outflow of the Spiegelwaal in Figure 3.8, where the LTD is interrupted by default in the 'Globaal Ontwerp Langsdammen'. Similarly, the LTDs are sure to conflict with the currently present groynes, which will be removed from the inner bend if an LTD is implemented. Therefore, only outer bend groynes can be lowered in the simulations in which LTDs and groyne lowering are implemented simultaneously.

3.6.3 Groyne lowering (GL)

The already present groynes in the Boven-Waal are visualized in Figure 3.9. As mentioned in Section 2.1, if one desires to govern the morphology of a river, the focus should be on medium discharges. Therefore, in order to have an effect on the river bed, the groynes should be lowered such that the groynes are overflowed for these medium discharges. Groynes in Dutch rivers may be lowered to a minimum of +1.2 meter OLR to remain a recognisable object in the river landscape (Bom & van Leeuwen, 2020). Therefore, the groynes in this research will be lowered to +1.20 meter OLR. This way, the maximum potential of groyne lowering within the current regulations can be explored. Similarly to the design of the LTDs, OLR 2022 will be used to determine the absolute lowering of the groynes. For the implementation of groyne lowering in the model input, only the weirs that represent the currently present groynes have been lowered to +1.2 meter OLR. Figure 3.10 shows these adapted weirs in the model input.

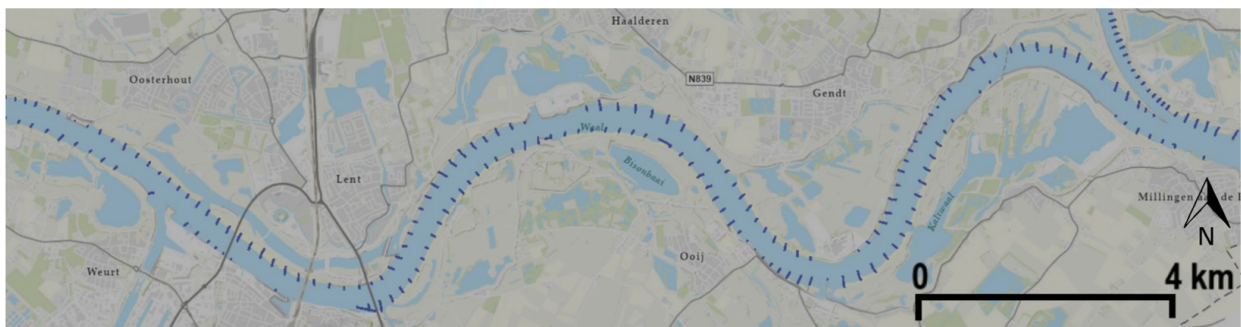

FIGURE 3.9: Currently present groynes in the Boven-Waal (rkm 867-890 in Figure 1.3), are marked as dark blue lines. This map originates from Waterdiepte Rijntakken (maps.rijkswaterstaat.nl).

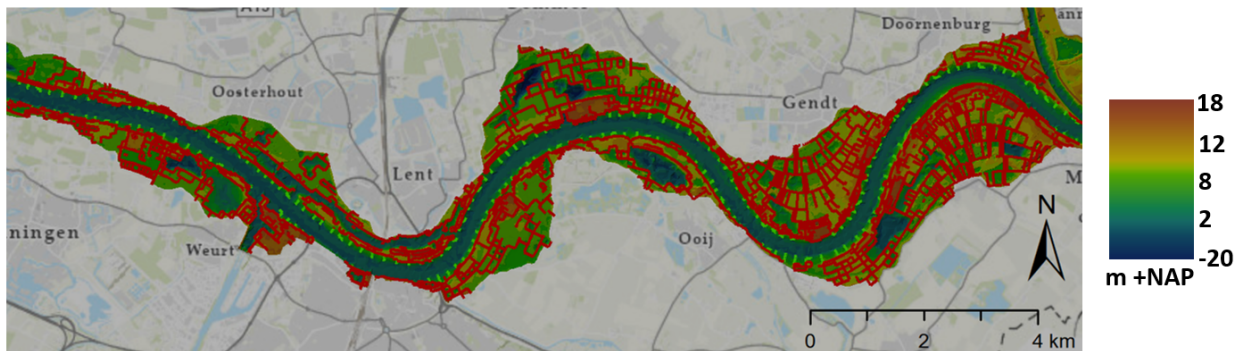

FIGURE 3.10: The present weirs in the model input of the Boven-Waal (rkm 868-892 in Figure 1.3). The currently present groynes in the Boven-Waal, are schematized as weirs in the model input. The weirs marked in green represent the groynes. The weirs marked in red are unchanged.

4 | Results

This chapter will analyse the outcomes of the different model simulations. First an analysis of the reference simulation is performed, to see how the model performs. The reference simulation (Sim_{REF}) sets the benchmark for the other simulations, as inferences can be made about the implemented river interventions by comparison with this reference simulation. Subsequently, the outcomes of Sim_{SC} will be analysed to enable answering the first research question. This will be followed by the presentation of the results of all performed simulations, so that the second research question can be answered. Lastly, the impact of the different combinations of river interventions on the consequences of bed degradation will be analysed. This way research question three can be answered.

4.1 Analysis of the reference simulation

First the hydraulics at the start of Sim_{REF} will be analysed and validated with measured data. Subsequently, the morphological development that follows out of these analysed hydraulics will be examined.

4.1.1 Hydraulics at the start of the simulation

Water levels

First the accuracy of the water levels at the start of Sim_{REF} will be determined. Figure 4.1 shows the modelled water levels in Sim_{REF} and the Q/h relationship along the Rhine Branches of 2022 (Rura-Arnhem, 2022). There is a visible overestimation of the higher discharges ($4353 \text{ m}^3/\text{s}$ - $7009 \text{ m}^3/\text{s}$), which is up to 19 centimeter, whereas the overestimation of the medium and low discharges ($1020 \text{ m}^3/\text{s}$ - $3384 \text{ m}^3/\text{s}$) is generally no larger than 10 centimeter. Only for a discharge of $1954 \text{ m}^3/\text{s}$ this 10 centimeter difference is exceeded just upstream of the bed groynes of Erlecom. This discrepancy is to be expected when using only one single Chézy roughness coefficient ($50 \text{ m}^{1/2}/\text{s}$) for the summer bed, which is necessary for the correct simulation of morphology. If water levels in the Boven-Waal are modelled to be higher than in reality, this implies that flow velocities will be lower and thus sediment transport will be lower. Impacts on sediment transport might be relatively large, as the relation between flow velocity and sediment transport is exponential. Moreover, a higher water level in the upstream section of the Boven-Waal will likely lead to additional flow towards the Pannerdensch Kanaal at the Pannerdensche Kop, compared to the measured data dating from 2022.

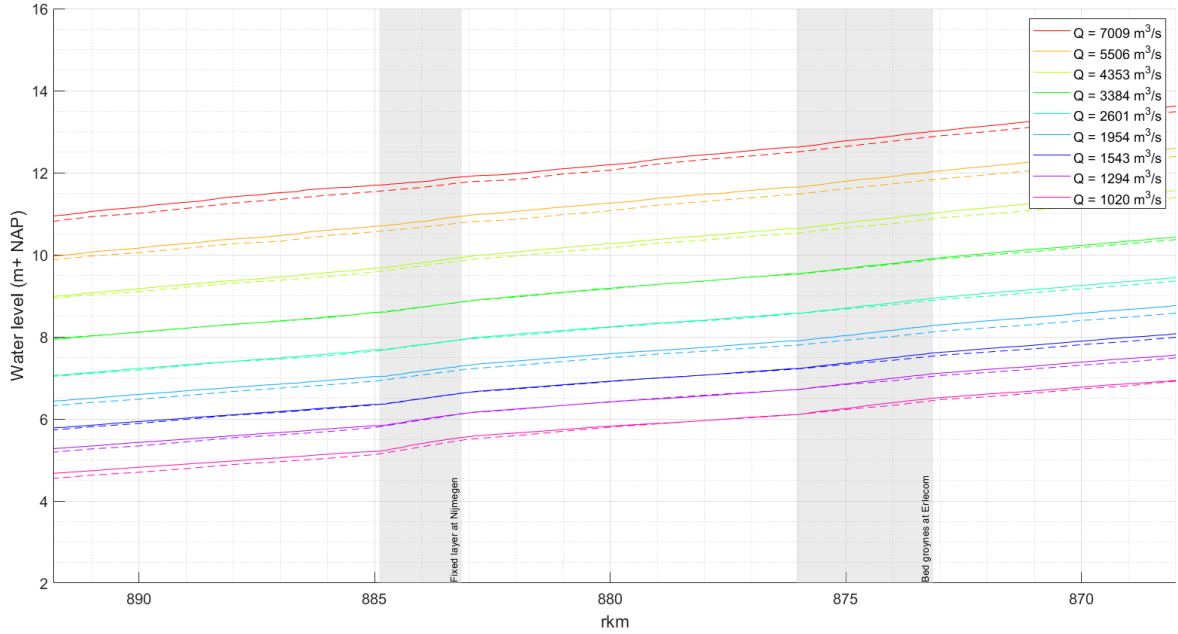

FIGURE 4.1: Comparison between the modelled water levels in the Boven-Waal by the DVR model at the start of Sim_{REF} (solid lines) and the Q/h relationship (dashed lines) of 2022 (Rura-Arnhem, 2022).

Discharge distribution

The discharge distribution at the Pannerdensche Kop is an important design variable for the future development of the Dutch Rhine delta. Therefore, it is required to behave as one would expect. So the discharge distribution at the start of the simulation should be close to the discharge distribution in reality. Besides, during sim_{REF} it is expected that the discharge distribution at the Pannerdensche Kop skews more and more towards the Waal, instead of the Pannerdensch Kanaal, as the Boven-Waal erodes more than the Pannerdensch Kanaal throughout the years in Sim_{REF} .

Figure 4.2 shows that this is what actually happens in the model. More discharge flows towards the Boven-Waal at the end of the simulation compared to the start of the simulation. Additionally, when looking closely at Figure 4.2, it can also be noticed that the discharge distribution at the start of the simulation is very close to the discharge distribution in reality. This discharge distribution in reality, originates from Krabbendam & van Putten (2024), who used water levels from 2022 and the 'vereffende afvoerverdeling' methodology (van Putten, 2023), to determine the discharge distribution at the Pannerdensche Kop. Interestingly, the upstream discharges with higher water levels in Figure 4.1 do not seem to have a noticeable influence on the discharge distribution at the Pannerdensche Kop, as deviations between the start of the simulation and the discharge distribution in reality (Figure 4.2) do not seem to coincide with the deviations in water levels (Figure 4.1).

From Figure 4.2, it can be concluded that the modelled discharge distribution at the Pannerdensche Kop is close to the discharge distribution in reality. Besides, the discharge distribution develops throughout Sim_{REF} as expected, as the Boven-Waal attracts more discharge at the Pannerdensche Kop at the end of the simulation compared to the start of the simulation.

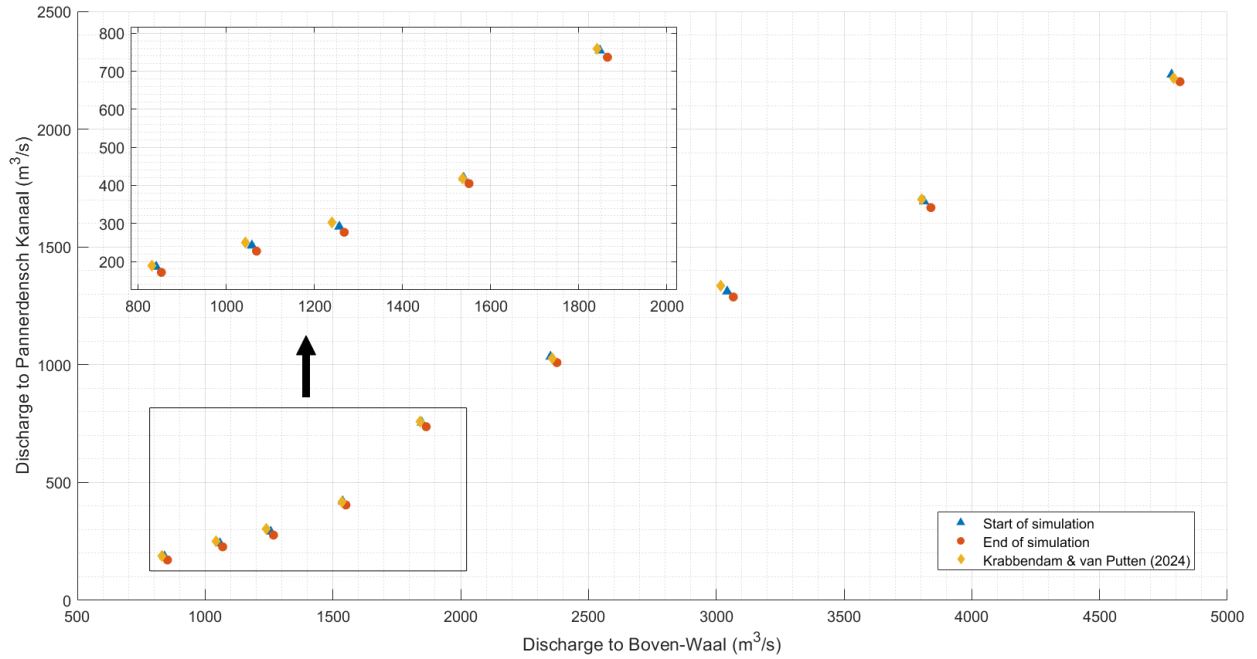

FIGURE 4.2: The discharge distribution at the Pannerdensche Kop for the nine different steady steps of the upstream hydrograph at the start of Sim_{REF}.

Flow velocities

Flow velocities are analysed, as they are directly related to sediment transport and thus related to the resulting morphological development. Figure 4.3 shows the width averaged flow velocity in the main channel of the Boven-Waal. It can be seen that higher upstream discharges translate to higher depth averaged velocities. This happens as a larger volume of water has to flow through the same main channel, as a response flow velocities will increase due to continuity. Additionally, less water will be in contact with the river bed and thus less energy will be lost to friction, which also causes higher flow velocities.

An interesting feature in Figure 4.3 is the increase in flow velocity over the fixed layer at Nijmegen and the bed groynes at Erlecom. Both features have a higher elevation than the surrounding river bed level (Figure 4.5), which suddenly forces the flow through a smaller cross-section and thus flow velocities will increase. This elevation difference is larger for the fixed layer at Nijmegen than for the bed groynes at Erlecom, hence the difference in magnitude. Besides, it can be noticed that this increase in flow velocity becomes progressively smaller for higher discharges. This is explained by the fact that the higher discharges have higher water levels. The higher the water level, the smaller the portion of the flow that has to overcome this sudden change in bed level height. This can also partially be seen in Figure 4.1, where an increased water level at the fixed layers can be noticed, especially during lower discharges. Lastly, between river kilometers 883 and 887, the flow velocity in the main channel for a discharge of 7009 m³/s is smaller than for a discharge of 5506 m³/s and at some locations for a discharge of 4353 m³/s as well. This is caused by the interaction with the floodplains at the end of the Spiegelwaal (Figure 3.4), which will be activated at a of discharge 7009 m³/s. Just before rkm 888, all discharge is forced to flow through the main channel again. This causes a backwater curve that reduces flow velocities upstream.

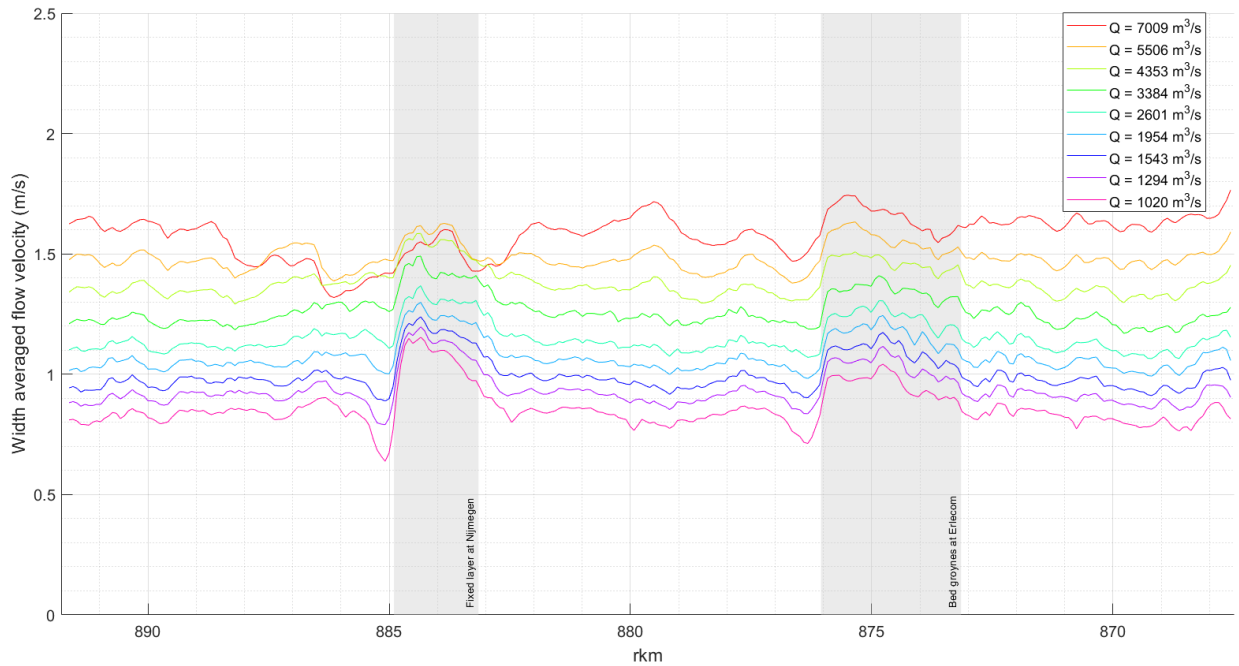

FIGURE 4.3: Width averaged flow velocities in the main channel of the Boven-Waal at the start of Sim_{REF} .

4.1.2 Morphological development

The resulting sediment transport as a response to the analysed hydraulics, is visible in Figure 4.4. Figure 4.4 shows that the absolute majority of the sediment transport originates from the medium discharges. The discharges coming from Lobith with the highest sediment transport rates are $1954 \text{ m}^3/\text{s}$ and $2601 \text{ m}^3/\text{s}$. Therefore, to control the morphology of the Boven-Waal, interventions should influence the flow for these discharges. The resulting morphological development in response to the sediment transport is visible in Figure 4.5 and 4.6. Figure 4.6 shows the sedimentation and erosion pattern in the Boven-Waal of Sim_{REF} after 20 years of morphological development. There seems to be a clear difference in morphological development between the upstream and downstream part of the Boven-Waal. The upstream part of the Boven-Waal seems to alternate between areas with erosion and sedimentation, whereas the downstream part of the Boven-Waal is largely marked by erosion. This distinct difference is better visualized in Figure 4.7. Here it can be noticed that there is significantly more bed degradation in the downstream part of the Boven-Waal ($-1.3 \text{ cm}/\text{year}$), as opposed to the upstream part of the Boven-Waal ($-0.35 \text{ cm}/\text{year}$). This discrepancy only grew larger over the years of simulation (Figure 4.7). When comparing Figure 4.5 with 4.6, it can be seen that the sedimentation and erosion patterns seem to roughly coincide with the local bed slope. The trend line in Figure 4.5 also shows that the bed slope in the upstream part of the Boven-Waal is more flat and that it becomes steeper in the downstream part of the Boven-Waal, which can explain why there is such a clear difference between the upstream and downstream part of the Boven-Waal.

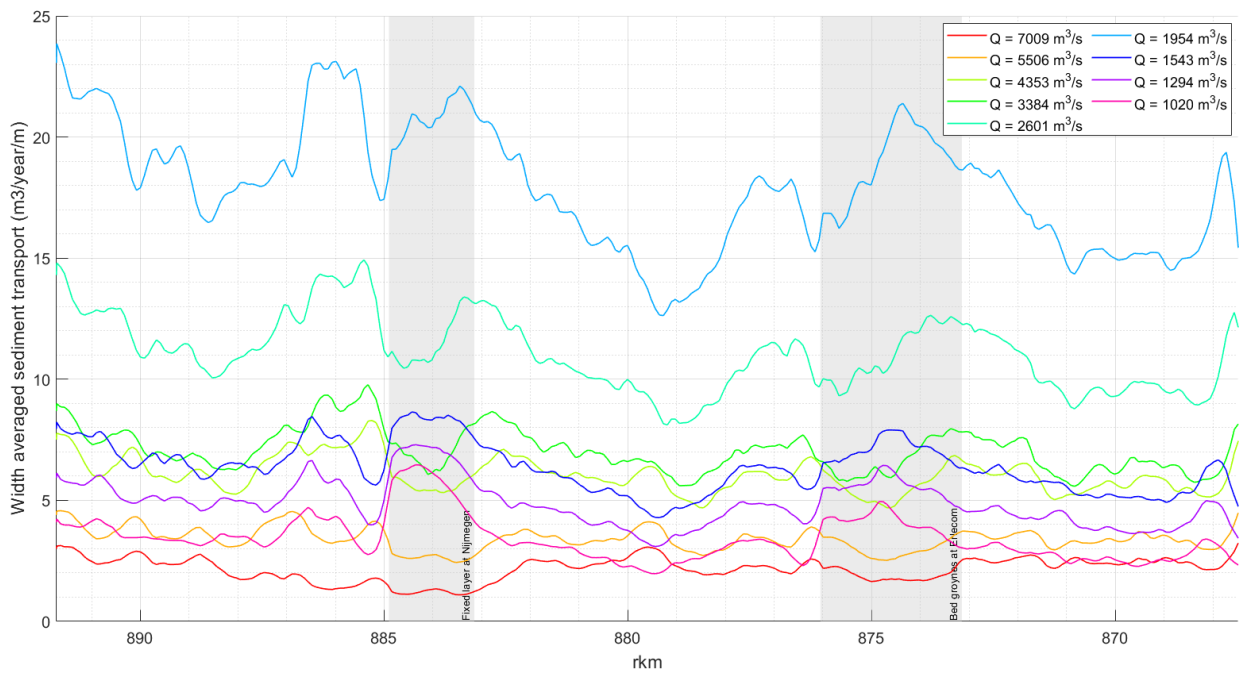

FIGURE 4.4: Yearly width averaged sediment transport in Sim_{REF} per upstream discharge coming from Lobith. A positive value indicates sedimentation (more sediment is entering the grid cell than leaving the grid cell). A negative value indicates erosion (more sediment is leaving the grid cell than entering the grid cell).

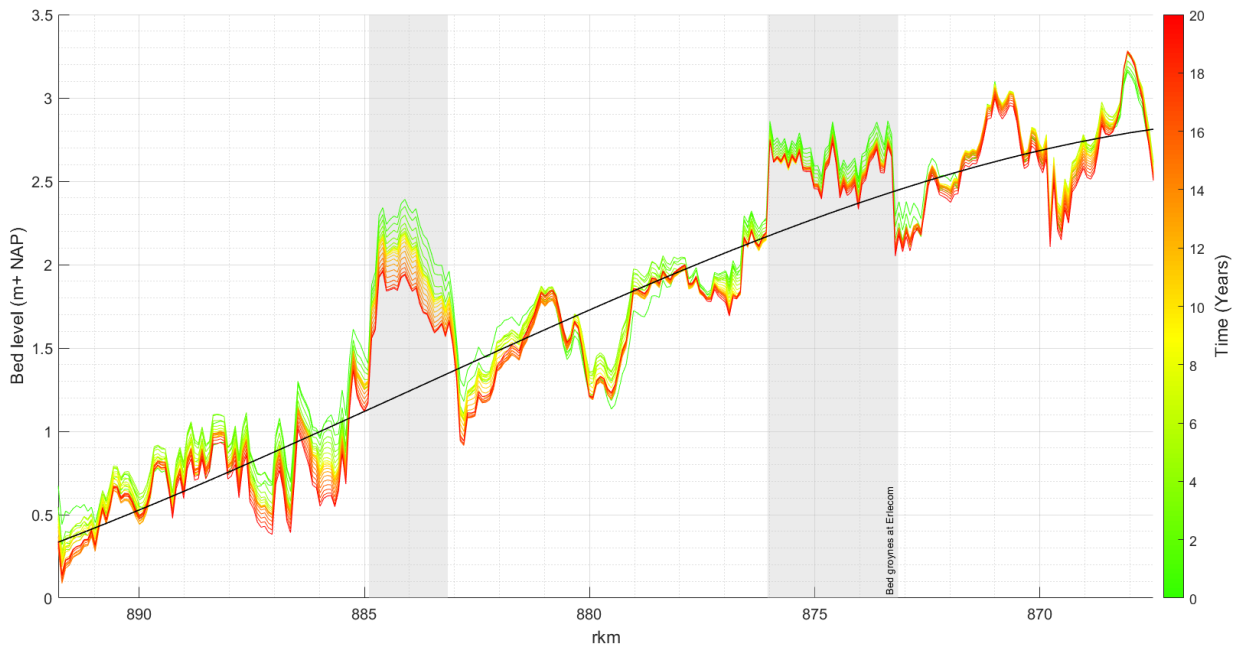

FIGURE 4.5: Cross-sectionally averaged bed level development through the 20 years of morphological simulation in Sim_{REF} in the Boven-Waal. The black line is a trend line.

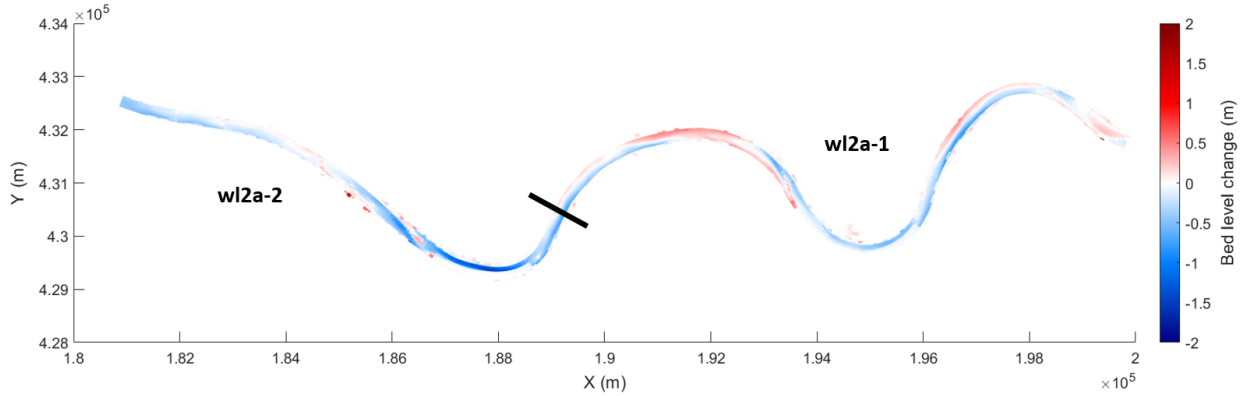

FIGURE 4.6: Bed level change after 20 years for Sim_{REF} in the Boven-Waal. Positive (red) grid cells indicate sedimentation. Negative (blue) grid cells indicate erosion. The black line divides the Boven-Waal into two partial domains, these being the upstream (wl2a-1) and downstream (wl2a-2) part of the Boven-Waal, that each show different morphological change.

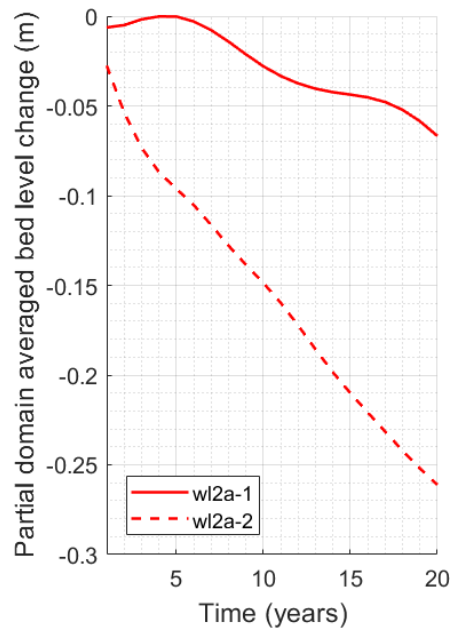

FIGURE 4.7: Domain averaged bed level change over the years compared to the start of Sim_{REF} . A positive value indicates domain averaged sedimentation, while a negative value indicates domain averaged erosion. A difference in morphological trend between the upstream part of the Boven-Waal (wl2a-1) and the downstream part of the Boven-Waal (wl2a-2) can be noticed.

Appendix E shows the difference between the initial bed level (Figure 4.8) and the bed level after 5, 10 and 15 years. Just as in Figure 4.7, it can be seen that slightly more erosion occurs over the years in the upstream section of the Boven-Waal, while the erosion in the downstream section of the Boven-Waal becomes progressively larger. Additionally, the bed level at the start of Sim_{REF} (Figure 4.8) shows no remarkable results, except for the previously described high bed levels in the inner bends of the fixed layer at Nijmegen and the bed groynes at Erlecom. When comparing Figure 4.6 with Figure 4.8, it can be seen that erosion mostly occurs where the bed level has the highest elevation and that sedimentation occurs mostly where the bed level has a lower elevation. This is especially visible in the lower outer and higher inner bends.

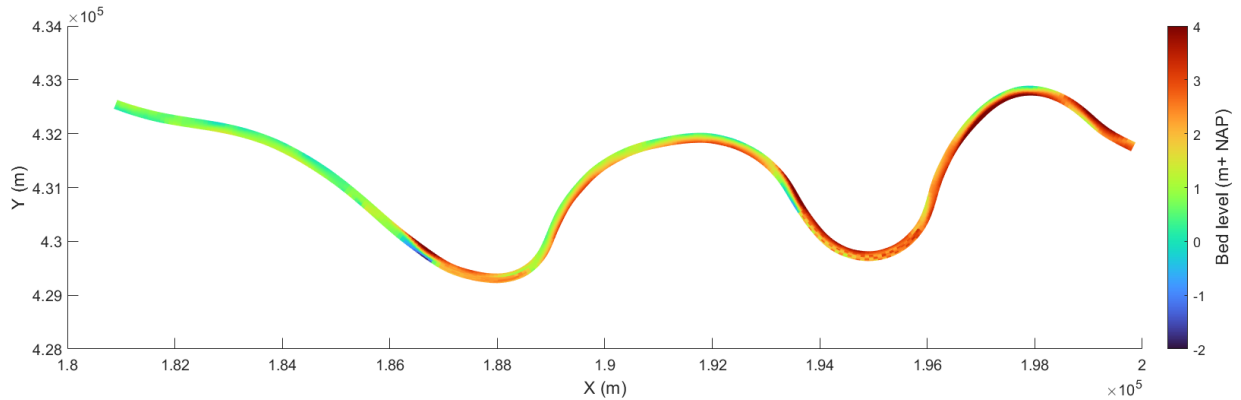

FIGURE 4.8: Bed level at the start of the simulation for Sim_{REF} in the Boven-Waal. This includes the 2 years of morphological spin-up described in Section 3.5.

Lastly, Figure 4.9 shows that initially there is a strong reaction of the bed, which is expected as it is the output of a model. Although, due to the morphological spin-up (Section 3.5), this reaction is shorter and less intense. After about 5 years, bed level changes are happening more gradual.

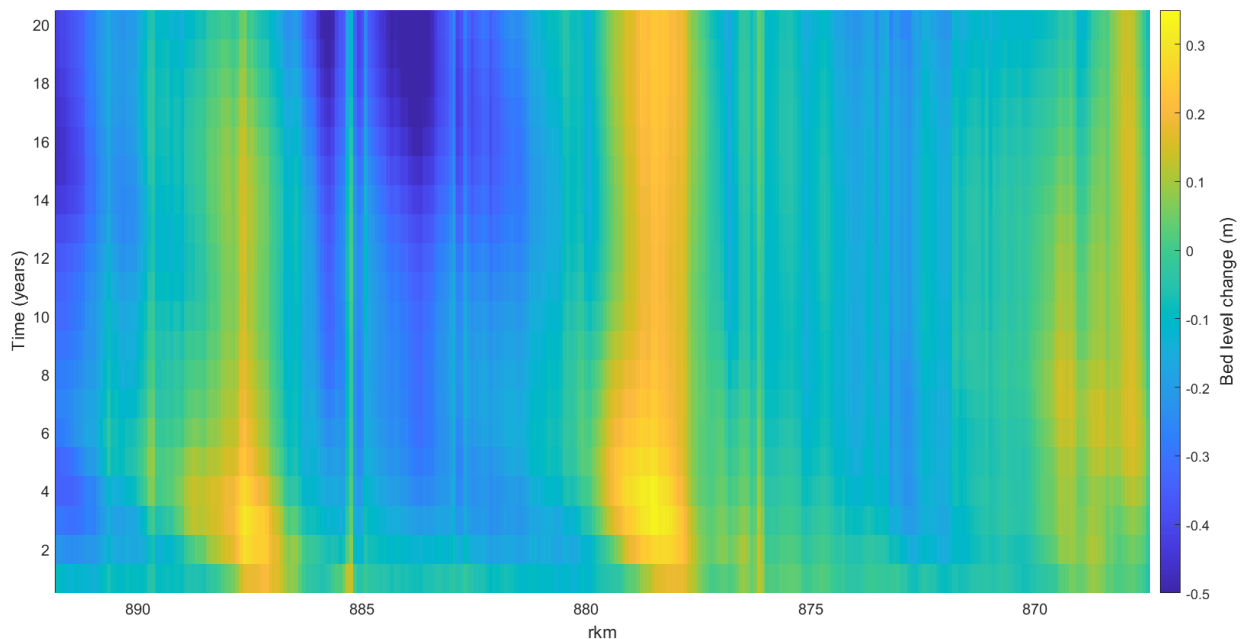

FIGURE 4.9: Bed level change through space (x-axis) and time (y-axis) for Sim_{REF}. An estimate of the propagation speed of the bed is shown in red.

4.2 Analysis of the schematised model simulations

This section presents the results that will answer the research questions. First, the division of discharge over the summer and winter bed after 20 years will be analysed, compared to Sim_{REF} . This will aid the understanding of the morphological development of the different simulations in the subsequent sections, as it shows how the different river interventions have changed the hydraulics.

Mitigating bed degradation is the main focus of this research. To answer the first research question, the morphological results of Sim_{SC} will be analysed. This will show how the starting package of interventions, consisting of low effort side channel (re)construction and summer dike lowering, impacts the morphology of the Boven-Waal. This will be followed by a morphological assessment of Sim_{SC-GL} , $\text{Sim}_{SC-GL-LTD}$, Sim_{SC-LTD} and Sim_{GL-LTD} , which can show the cumulative effect of the different river interventions, hereby enabling the formulation of an answer to the second research question. To assess if the different combinations of river interventions also mitigate the consequences of bed degradation, the impacts on safe navigation, flood protection and fresh water availability are assessed. This can show which combination of river interventions complies best with the goals of IRM and mitigates consequences of bed degradation the most, hereby enabling the formulation of an answer to the third research question.

4.2.1 Analyses of the division of discharge after 20 years for all simulations

To get an insight into how the river interventions affected the flow in the Boven-Waal, the fraction of the discharge flowing through the main channel is visualized for each simulation compared to the reference simulation (Sim_{REF}). The fraction of flow passing through main channel is key for controlling the morphology of the main channel river bed. Generally, a decrease in discharge through the main channel results in lower flow velocities, thereby increasing sedimentation within the channel. Flow over the groynes is considered flow outside of the main channel, in order to also be able to assess the effects of groyne lowering.

Figure 4.10 gives additional insight into the functioning of the different side channels and the summer dike lowering at the end of Sim_{SC} . The Kaliwaal (2) and Bizonbaai (4) are extracting discharge from the main channel at OLA. Whereas the Klompenwaard (1), Gendtsche Waard (3) and Oude Waal (6) only start extracting a small amount of discharge from the main channel at an upstream discharge of $1954 \text{ m}^3/\text{s}$. Although in different amounts, depending on their width. Lastly, the Bemmelse Waard (5) only seems to extract discharge from the main channel from an upstream discharge of $2601 \text{ m}^3/\text{s}$ onwards.

The only summer dike lowering that seems to cause a significant increase in extracted discharge to the floodplains in Sim_{SC} , are the lowered summer dikes in the Bemmelse Waard and to a much lesser extent the lowered summer dikes close to the Oude Waal, but only during an upstream discharge of $7009 \text{ m}^3/\text{s}$.

For Sim_{SC-GL} , the pattern of discharge extraction across the Boven-Waal looks similar to the pattern of Sim_{SC} (Figure 4.10). However, there is additional discharge extraction from the main channel across the whole Boven-Waal. After 20 years, the lowered groynes seem to start overflowing from an upstream discharge of $1954 \text{ m}^3/\text{s}$ onwards. However, at the locations at which side channels extract discharge from the main channel at OLA, the groyne lowering already starts having an impact from OLA onwards. At the other side channel locations, the same process is visible. This logically results from the fact that side channels extract discharge from the main channel and thus cause lower main channel water levels. So relatively more discharge is flowing outside the main channel over the groynes.

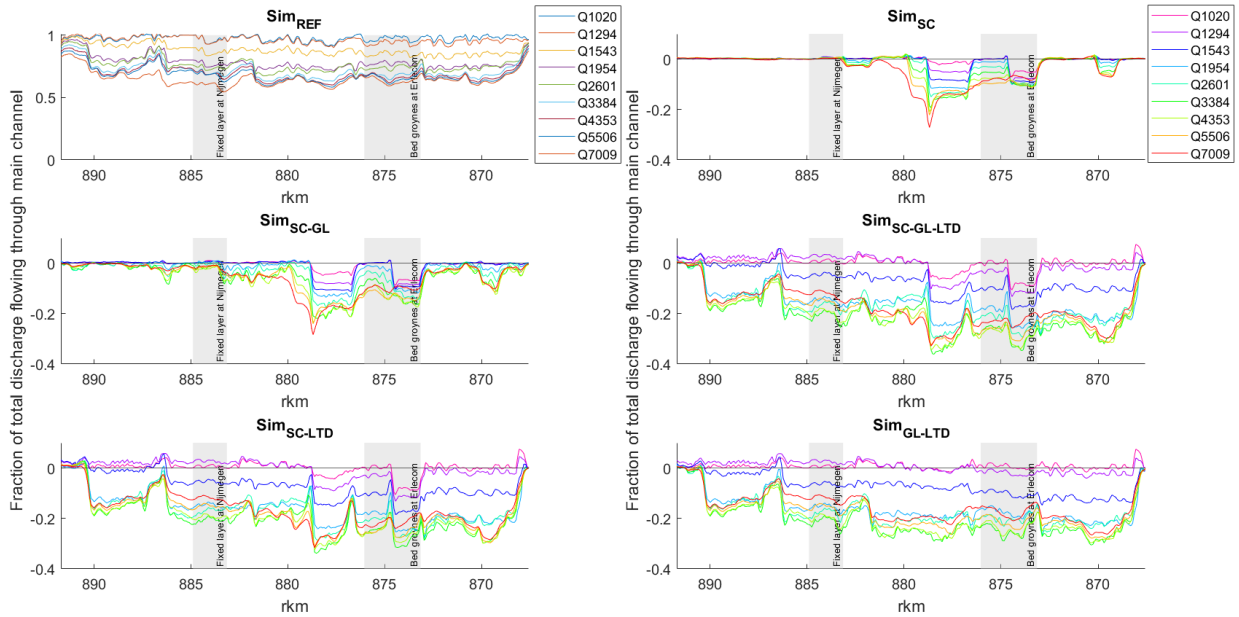

FIGURE 4.10: Fraction of the flow passing through the main channel for all simulations compared to Sim_{REF} after 20 years. The actual discharge division of Sim_{REF} is shown, whereas the discharge divisions of the other simulations are relative to Sim_{REF}. Positive values indicate more flow through the main channel relative to Sim_{REF}. Negative values indicate less flow through the main channel relative to Sim_{REF}.

The addition of LTDs in Sim_{SC-GL-LTD} causes large changes (Figure 4.10). More discharge flows through the main channel for OLA and 1294 m^3/s , as the LTD sills are not overflowed yet for these discharges after 20 years. Only at locations of side channels that are already activated at OLA, a decrease in discharge outside the main channel is visible for these lower discharges, compared to Sim_{REF}.

When comparing Sim_{SC-LTD} and Sim_{SC-GL-LTD}, groyne lowering seems to have little effect (Figure 4.10). Compared to side channels and LTDs, the effect of groyne lowering on the division of discharge between the main channel and the floodplains is relatively small. This is exacerbated by the fact that in simulations in which groyne lowering and LTDs are combined, there are only groynes in the outer bend that can be lowered. However, groyne lowering seems to have no effect at all for certain locations and discharges. This is caused by side channels and LTDs that extract a large amount of discharge from the main channel already, causing a lower water level at these locations. In turn the lowering of groynes has no effect here, as water levels seem to be below the level of the lowered groynes. By comparison of Sim_{SC-GL-LTD} and Sim_{GL-LTD}, it can be seen that the lowering of groynes in Sim_{SC-GL-LTD} only seems to start having an effect from an upstream discharge of 2601 m^3/s onwards. The impact of a combination of side channels and LTDs on the water levels in the main channel cause the same implemented groyne lowering as in Sim_{SC-GL} to take effect for higher discharges.

Lastly, the exclusion of side channels and summer dike lowering in Sim_{GL-LTD} logically causes a more gradual pattern of discharge division along the Boven-Waal (Figure 4.10).

4.2.2 Analyses of the morphological effect of Sim_{SC}

To answer the first research question, a comparison between the morphological development at the end of the reference situation (Sim_{REF}) and at the end of Sim_{SC} is made. Sim_{SC} includes altering of the floodplains via (re)construction of side channels and summer dike lowering. The difference in morphological development is shown in Figure 4.11. The (re)constructed side channels are clearly visible, as the bed is logically deeper here than at the end of Sim_{REF}, where these grid cells were still part of the higher lying floodplains. The side channels will be numbered from upstream to downstream. They will be referred to with their original name and given number.

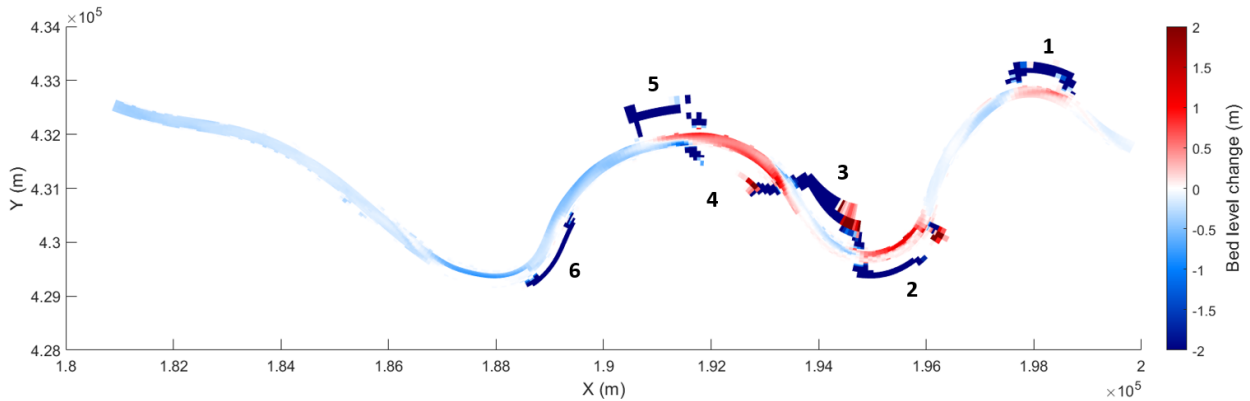

FIGURE 4.11: Bed level development in the Boven-Waal after 20 years in Sim_{SC}, compared to Sim_{REF}. Positive values indicate sedimentation (red), while negative numbers indicate erosion (blue). The implemented side channels are numbered: 1 = Klompenwaard, 2 = Kaliwaal, 3 = Gendtsche Waard, 4 = Bizonbaai, 5 = Bemmelse Waard and 6 = Oude Waal.

Figure 4.11 shows that the different side channels certainly do not have the same effect on the bed level in the main channel. From upstream, the first side channel is the Klompenwaard (1), which already exists in reality. However, it was made wider and deeper in Sim_{SC}, which is also visible from the results. Additional sedimentation occurs in the main channel over the length of the side channel, followed by some extra erosion downstream of its outlet. It corresponds to how one would expect a single side channel to react, based on previous research of Oldenhof (2021), Paarlberg & Schippers (2020) and Welsch (2021). Different from the isolated Klompenwaard (1), the side channels Kaliwaal (2), Gendtsche Waard (3), Bizonbaai (4) and Bemmelse Waard (5), are chained. However, it immediately shows this chainage of connected lower lying areas in the floodplains does not induce a uniform effect on the bed level in the main channel. This is caused by the fact that the depth of the side channels is dependent on the elevation of the lower lying areas in the floodplains (Table 3.2) to which they are connected to.

The Kaliwaal (2) and Bizonbaai (4) seem to induce considerable sedimentation in the main channel. Whereas, the Gendtsche Waard (3) and Bemmelse Waard (5) seem to have little effect. A logical explanation for this difference between these side channels, is that the Kaliwaal (2) and Bizonbaai (4) have the lowest elevation. Therefore, they are already activated at OLA (1020 m³/s), reducing flow velocities in the main channel more often throughout the year and thus inducing more sedimentation. The Bemmelse Waard (5) is only fully activated for a discharge of 3384 m³/s or higher, which seems to be too sporadic to induce any lasting sedimentation over its length in the main channel. Especially combined with the outflow of the Bizonbaai (4), which seems to cause considerable scour. The fact that the Gendtsche Waard (3) induces little effect in the main channel, seems to be related to the considerable amount of sedimentation at the inflow. This sedimentation causes the Gendtsche Waard (3) only to be activated for increasingly higher discharges throughout

the simulation period. At the start of the morphological simulation, the Gendtsche Waard (3) is already activated during a discharge of $1020 \text{ m}^3/\text{s}$, while at the end of the simulation, it is only activated for a discharge of $1954 \text{ m}^3/\text{s}$ and higher. Even though the Kaliwaal (2) and Bizonbaai (4) also experience sedimentation in the inflow (Figure 4.11), this does not cause them to be less effective over time. This is likely caused by the fact that the Gendtsche Waard (3) has an elevation of 5.6 meter +NAP, whereas the Kaliwaal (2) and Bizonbaai (4) have elevations of 4.6 meter +NAP and 5.0 meter +NAP respectively (Table 3.2). So the same amount of sedimentation in them does not lead to the same effect on their activation frequency. A distinct difference, is that the side channel in the Gendtsche Waard (3) is bifurcating from the main channel in the middle of an inside bend, where secondary flow is strong. At this location, secondary flow is thus directed into this side channel. This secondary flow is likely to be enhanced by the outflow of the Kaliwaal (2) into the main channel. Additionally, there is much available sediment close to the entrance of the Gendtsche Waard (3), caused by the sedimentation over the length of the Kaliwaal (2). All together, this seems to lead to sedimentation in the inlet of the side channel towards the Gendtsche Waard (3), which eventually causes a decrease in effectiveness of this side channel over time.

Figure 4.12 shows that the side channel in the Gendtsche Waard (3) never actually contributed to sedimentation in the main channel. Suggesting that this side channel only extracts a large amount of sediment from the flow, that is deposited on the bed of the side channel itself. The outlet of the Bizonbaai (4) seems to experience opposite issues due to secondary flow, as it connects to the main channel in the middle of an inner bend. Here an interaction between the primary main channel flow, secondary flow and outflow of the Bizonbaai (4) seem to cause local scour.

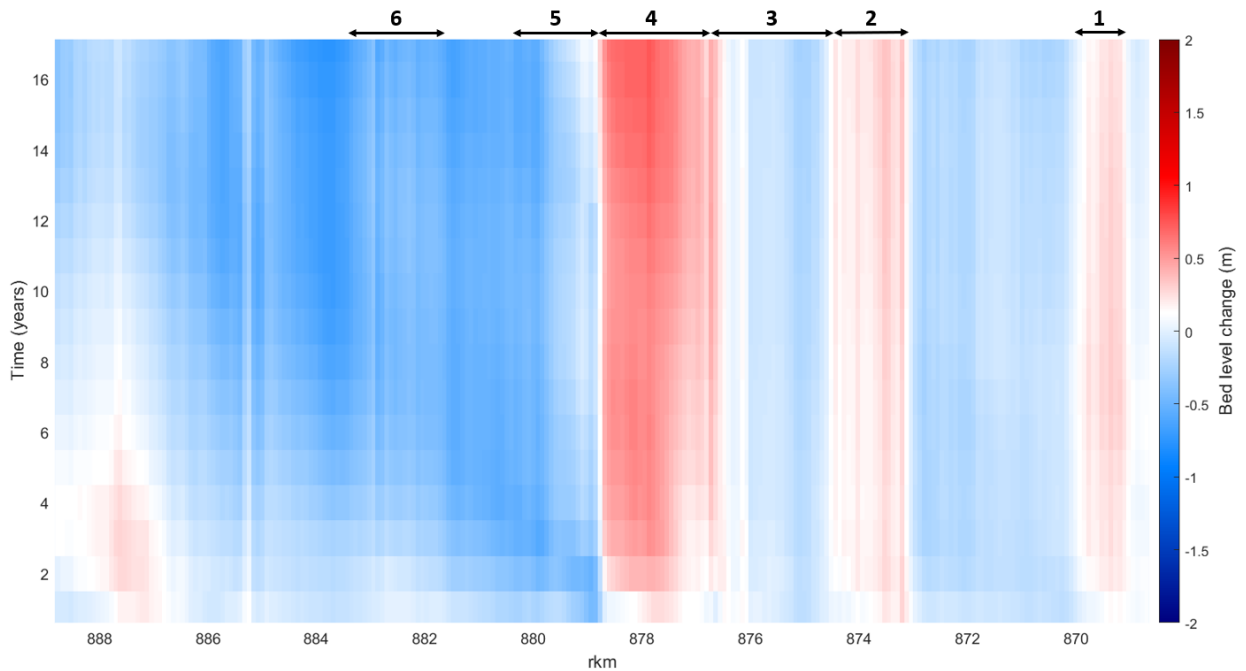

FIGURE 4.12: Width averaged bed level development in the Boven-Waal after 20 years in Sim_{SC} , compared to Sim_{REF} . The x-axis shows the river kilometers from downstream (left) to upstream (right). The y-axis shows time in years. So every rectangle represents cross-sectional averaged bed level change at a certain location in the main channel of the Boven-Waal at a certain time in the simulation. Positive values indicate sedimentation (red), while negative numbers indicate erosion (blue). The implemented side channels are numbered: 1 = Klompewaard, 2 = Kaliwaal, 3 = Gendtsche Waard, 4 = Bizonbaai, 5 = Bemmelse Waard and 6 = Oude Waal.

Lastly, the Oude Waal (6) seems to have little effect on the main channel bed. It was expected to have less effect than the others, as it is the side channel that has the smallest width. However, it does reduce erosion over in the main channel over its length, compared to the surrounding river bed, which is better visible in Figure 4.12. It seems likely that the upstream side channels caused so much sedimentation, that larger side channels are needed downstream to generate a similar effect on the main channel bed level. The side channels capture sediment that would normally flow further downstream. This sediment is deposited both on the main channel and side channel bed.

It should be noted that the side channels by no means lead to a uniform reduction of bed degradation. Instead, the side channels exacerbate the already large gradient in bed degradation between the upstream and downstream section of the Boven-Waal (Figure 4.7). So in this case, the altering of floodplains via side channels and summer dikes lowering actually worsens erosion, which is visible in Figure 4.11 and 4.12. In fact, Figure 4.13 shows that after 20 years of simulation, the domain averaged bed level change is even worse for Sim_{SC} than for the reference simulation. It shows that even though additional sedimentation is present in the upstream section of the Boven-Waal, the interventions cause even more erosion in the downstream section of the Boven-Waal. This additional erosion is likely induced by an even steeper slope between the upstream and downstream part of the Boven-Waal compared to Sim_{REF} (Figure 4.5). Besides, the sediment that is deposited on the bed of the main channel and the side channels cause less sediment availability in the downstream part of the Boven-Waal.

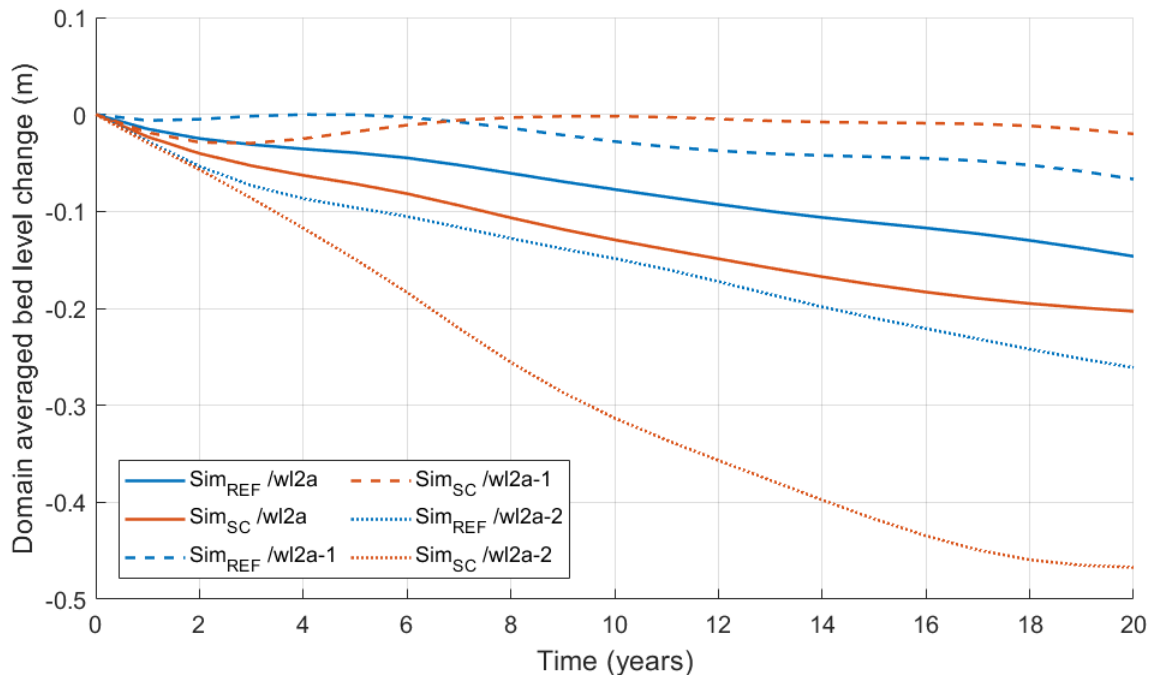

FIGURE 4.13: Domain averaged bed level development in the Boven-Waal throughout 20 years of morphological simulation. The blue lines represent the reference simulation (Sim_{REF}). The orange lines represent Sim_{SC} . The whole Boven-Waal is abbreviated to wl2a. The upstream section of the Boven-Waal is abbreviated to wl2a-1. The downstream section of the Boven-Waal is abbreviated to wl2a-2. A positive value indicates sedimentation averaged over the whole domain. A negative value indicates erosion averaged over the whole domain.

4.2.3 Analyses of the morphological effects of all simulations

To answer the second research question, the cumulative effect of the different combinations of river interventions on morphology will be analyzed. These simulations being Sim_{SC} , Sim_{SC-GL} , $\text{Sim}_{SC-GL-LTD}$, Sim_{SC-LTD} and Sim_{GL-LTD} . Sim_{SC} is also included in this analyses again, to enable comparison between all simulations simultaneously.

Domain averaged bed level development

The domain averaged bed level change throughout 20 years of morphological simulation gives a first impression into how each of the different simulations performs (Figure 4.14). It is remarkable that not only Sim_{SC} , but also Sim_{SC-GL} has a lower domain average bed level change than Sim_{REF} . Although the addition of groyne lowering seems to increase sedimentation rates in Sim_{SC-GL} compared to Sim_{SC} , this increase is only directly visible in the upstream section of the Boven-Waal (Figure 4.14B). The groyne lowering in the downstream section of the Boven-Waal in Sim_{SC-GL} seems to only prevent additional erosion that would be caused by groyne lowering in the upstream section of the Boven-Waal, when compared with Sim_{SC} . The same is true when comparing Sim_{SC-LTD} and $\text{Sim}_{SC-GL-LTD}$. So, groyne lowering only seems to have added effect on mitigating bed degradation in the upstream section of the Boven-Waal.

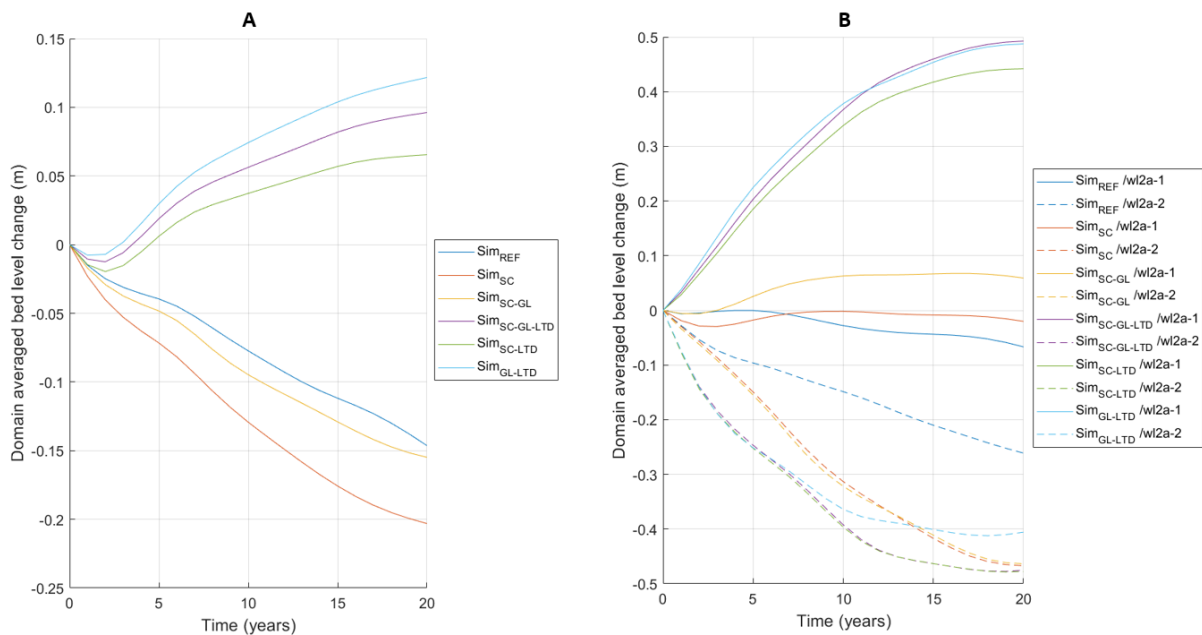

FIGURE 4.14: The domain averaged bed level development in the Boven-Waal for the different simulations throughout 20 years of morphological simulation (A). The domain averaged bed level development in the Boven-Waal split into an upstream and downstream section (B). The upstream section of the Boven-Waal is abbreviated to wl2a-1. The downstream section of the Boven-Waal is abbreviated to wl2a-2. Both are visible in Figure 4.6.

From Figure 4.14A, it can also be noted that the simulations that include LTDs ($\text{Sim}_{SC-GL-LTD}$, Sim_{SC-LTD} and Sim_{GL-LTD}) all have a net sedimentation rate across the whole domain after 3 to 4 years (Figure 4.14A). When side channels and summer dike lowering are included simultaneously with LTDs, erosion seems to increase, especially in the downstream section of the Boven-Waal (Figure 4.14B), where no side channels are implemented. Therefore, Sim_{GL-LTD} seems to achieve the most favourable domain averaged bed level change out of the three simulations that include

LTDs. This is mainly caused by a decrease in erosion in the downstream section of the Boven-Waal (Figure 4.14B).

Lastly, it is interesting to see that both the sedimentation in the upstream section and the erosion in the downstream section of the Boven-Waal are slowing down at the end of the simulations (Figure 4.14B). The erosion in the downstream section of the Boven-Waal even seems to decrease again after 20 years for $Sim_{SC-GL-LTD}$, Sim_{SC-LTD} and Sim_{GL-LTD} . In contrary, Sim_{REF} shows no indication of slowing down the erosive trend. Looking at the trends of Sim_{SC} and Sim_{SC-GL} , it seems likely that Sim_{REF} would eventually have more erosion after more than 20 years (Figure 4.14A).

Width averaged bed level development

The width averaged bed level change throughout the Boven-Waal gives a more in-depth view of what is happening in each of the simulations (Figure 4.15). The effects on the bed level after 20 years of morphological simulation are clearly visible for the individual river interventions.



FIGURE 4.15: Bed level changes compared to Sim_{REF} after 20 years of morphological simulation in the Boven-Waal. Negative values indicate erosion after 20 years compared to Sim_{REF} . Positive values indicate sedimentation after 20 years compared to Sim_{REF} . Letters A and B denote the LTDs shown in Figure 4.16 and 4.17.

The smallest effect on the bed level is caused by groyne lowering. This can be seen in Figure 4.15 via comparison between Sim_{SC} and Sim_{SC-GL} and between $Sim_{SC-GL-LTD}$ and Sim_{SC-LTD} . The effect of groyne lowering seems limited to an approximate increase of the cross-sectionally averaged main channel river bed by 1 to 10 centimeter. Groyne lowering seems to have less effect when combined with both side channels and LTDs. This is caused by the discharge that the side channels and LTDs extract from the main channel, causing lower water levels and thus a smaller portion of the flow that is affected by the groyne lowering. Lastly, it seems that when lowering of groynes is implemented, it causes sedimentation in the upstream part of the Boven-Waal, hereby making the

bed slope steeper towards the downstream part of the Boven-Waal and thus inducing additional erosion downstream. This is especially visible when comparing Sim_{SC} and Sim_{SC-GL} .

The effect of side channels is also clearly visible from Figure 4.15. A notable bump on the river bed can be seen between rkm 869-870, 873-875 and 876-87, which are the locations of the effective side channels described in Section 4.2.2. By comparing $\text{Sim}_{SC-GL-LTD}$ with Sim_{GL-LTD} , it can be seen that these side channels only cause additional sedimentation in the main channel at the location at which they are implemented. Sim_{GL-LTD} shows that by excluding side channels, the bed slope between the upstream and downstream section of the Boven-Waal is less steep and thus a slightly higher overall bed level is achieved.

The largest effect is caused by the implementation of LTDs (Figure 4.15). Compared to Sim_{REF} , the LTDs caused considerable sedimentation in the upstream section of the Boven-Waal, while simultaneously causing additional erosion in some parts of the downstream section of the Boven-Waal. However, the absolute effect of the LTDs seems to be relatively constant throughout the whole Boven-Waal, as it increases the bed by approximately 1 meter, compared to the surrounding bed.

More inferences can be made about the effect of the LTDs via comparison between Sim_{SC} and Sim_{SC-LTD} and between Sim_{SC-GL} and $\text{Sim}_{SC-GL-LTD}$ in Figure 4.15. The simulations that include LTDs cause a higher bed level almost everywhere throughout the domain of the Boven-Waal, compared to the simulations without LTDs. However, if there is suddenly no LTD present anymore, it will result into a large erosion pit, for example, downstream of rkm 891, where the last LTD ends. For the simulations that include LTDs, there are two other noticeable erosion pits compared to the simulations without LTDs. The most upstream one from rkm 881 to 883 can be explained by the riparian channel failing to extract a similar portion of the discharge, compared to the preceding LTDs (Figure 4.10). Still, the LTD crest narrows the main channel and thus more discharge has to flow through the same main channel. As a result, flow velocities will be higher compared to the reference simulation and thus more erosion is induced here. The erosion pit from rkm 886 to rkm 887 is located just after the outflow of the Spiegelwaal. The LTD here fails to extract an equal fraction of the discharge compared to the upstream LTDs (Figure 4.10). This is likely caused by the outflow of the Spiegelwaal that is pulled in the direction of the faster main channel flow. This sudden increase in discharge in the main channel causes higher flow velocities and thus induces erosion.

These erosion pits are exacerbated by the fact that more sediment is already captured upstream of this location in these simulations. Over time these erosion pits get deeper, which decreases water levels. This in turn causes the sills of the LTDs to be overflowed less often, which leads to these most downstream LTDs becoming less efficient over time. Figure 4.16 shows that this is exactly what happens to the LTDs in the downstream section of the Boven-Waal. The data in Figure 4.16 is shown during a discharge of 1543 m³/s, as this is the lowest discharge for which the LTDs are activated after 20 years of morphological simulation (Figure 4.10). As an example, the depth averaged flow velocities and water depths of the riparian channel of the most downstream LTD (LTD A in Figure 4.15) are shown in Figure 4.16. Both depth averaged flow velocities (A1 in Figure 4.16) and water depths (A2 in Figure 4.16) are decreasing over time in the riparian channel and thus less discharge flows through the riparian channel of the most downstream LTD. Figure 4.16 also shows that something different is happening to the LTDs in the upstream section of the Boven-Waal. As an example, the depth averaged flow velocities and water depths of the riparian channel of the most upstream LTD (LTD B in Figure 4.15) are shown in Figure 4.16. Depth averaged flow velocities (B1 in 4.16) increase here while water depths (B2 in 4.16) remain more or less equal over time in the riparian channel, meaning that more discharge flows through the riparian channel of the most upstream LTDs over time.

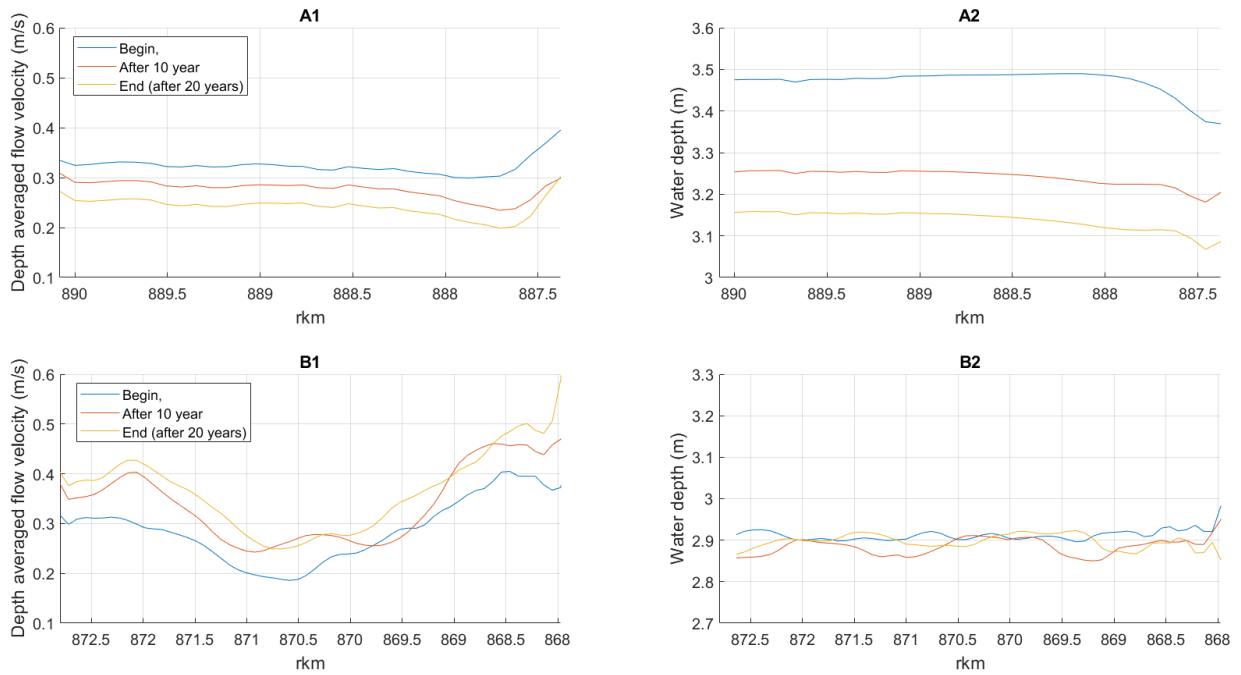

FIGURE 4.16: Depth averaged flow velocities (1) and water depths (2) in the riparian channel of the most downstream (A) and upstream LTD (B) in the Boven-Waal at a discharge of 1543 m/s. The data in the plots is from $Sim_{SC-GL-LTD}$ after 20 years of morphological simulation.

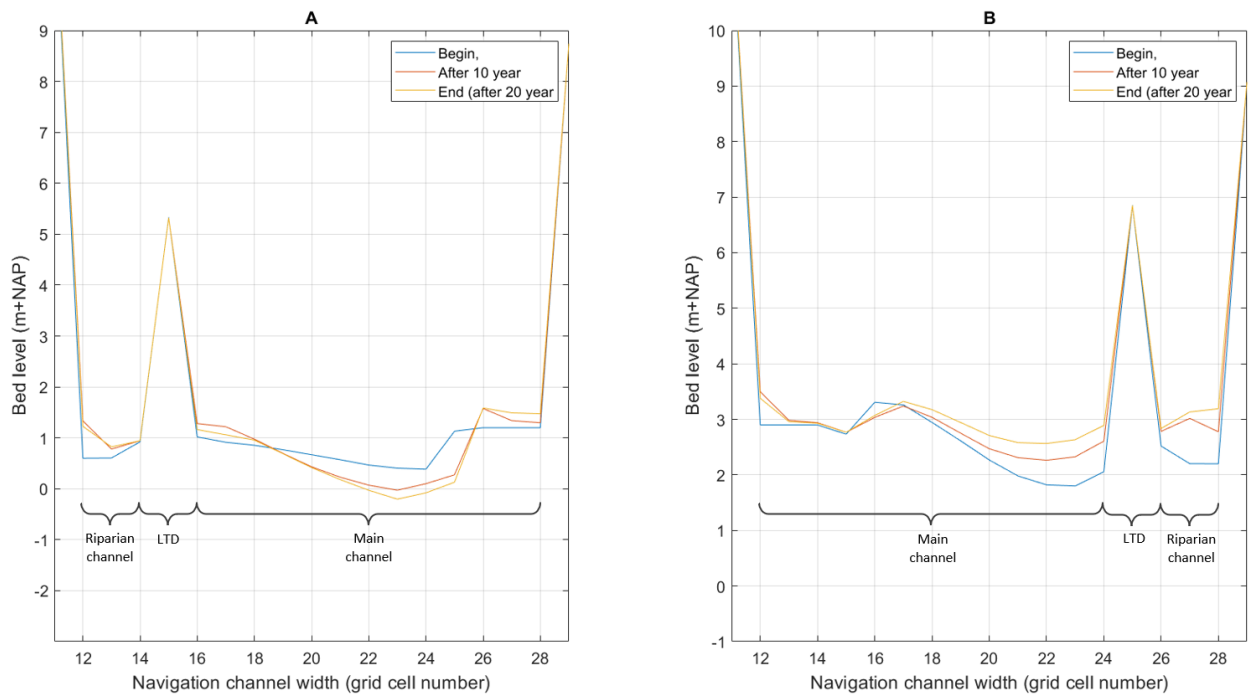

FIGURE 4.17: Cross-sectional bed level changes in $Sim_{SC-GL-LTD}$ at the start of an LTD in the downstream section of the Boven-Waal (A) and in the upstream section of the Boven-Waal (B). The x-axis shows the cross-sectional width of the navigation channel by grid cell number.

Though there is also similarity between the upstream and downstream LTDs, as all LTDs experience sedimentation in the riparian channel (Figure 4.17). However, the main channel bed of the downstream LTD is eroding over time (A in Figure 4.17), whereas the main channel bed of the upstream LTD experiences sedimentation over time (B in Figure 4.17). Hereby ensuring that the upstream LTD still functions after 20 years, while there seems to be a possibility that the downstream LTD loses its functionality if the eroding trend in the main channel can not be countered. It has to be noted that in reality sedimentation will occur at the inside of the riparian channel and erosion will occur on the outside of the riparian channel via bank erosion (Flores et al., 2022). This does not happen in the model, as the grid cells in the floodplains are non-erodible.

Bed level development throughout the Dutch Rhine branches

To assess the effect of the implementation of different combinations of river interventions in the Boven-Waal on the rest of the Dutch Rhine branches, the domain averaged bed level change is visualized in Figure 4.18 for the Boven-Rijn, Pannerdensch Kanaal, Boven-Waal, Midden-Waal and Beneden-Waal. Figure 4.18 shows that for every simulation, a lower bed level is caused in the Boven-Rijn, Midden-Waal and Beneden-Waal, whereas a higher bed level is present in the Pannerdensch Kanaal, compared to Sim_{REF} . All river interventions have essentially widened the Boven-Waal, which causes more discharge to flow to the Boven-Waal compared to Sim_{REF} . This also implies that less discharge will flow through the Pannerdensch Kanaal. This mentioned change in discharge distribution will be further addressed in Section 4.2.4. The reduced discharge directed to the Pannerdensch Kanaal will cause both incoming sediment and flow velocities to reduce in the Pannerdensch Kanaal, compared to Sim_{REF} . However, the river widening interventions in the Boven-Waal will also cause acceleration of the flow in the Boven-Rijn. This acceleration causes more erosion in the Boven-Rijn. The more river interventions are implemented in the Boven-Waal, the more the flow will accelerate, causing increasing erosion in the bed of the Boven-Rijn. This directly causes additional sediment to flow to both the Boven-Waal and Pannerdensch Kanaal. Apparently, this additional amount of sediment in the flow combined with the lower flow velocities in the Pannerdensch Kanaal during medium discharges causes sedimentation in the Pannerdensch Kanaal after 20 years for all simulations. For all simulations, a limited supply of sediment flows towards the Midden-Waal, compared to the Sim_{REF} , even though more sediment is flowing into the Waal. Depending on the simulation, this is either caused by deposition of sediment on the main channel of the Boven-Waal due to implemented river interventions or by loss of sediment in the main channel flow due to deposition in the side channels and riparian channels in the Boven-Waal. Either way, a lower bed level is present in the Midden-Waal for all simulations, which is also true for the Beneden-Waal, but to a much smaller extent.

It seems that the amount of sedimentation in the Boven-Waal is approximately equal to the induced erosion in the Midden-Waal for the simulations that include LTDs. This does not seem to be true for the simulations that do not include LTDs, which is explained by the deposition of sediment on the bed of side channels. The fact that Sim_{SC-LTD} does not experience this is explained by the fact that less sediment is deposited in the side channels, when they are combined with LTDs, which is visible in Appendix F. Besides, the results show that deposition of sediment is considerably lower on the bed of riparian channels of LTDs, compared to the bed of side channels. This can be explained by the reduced flow velocities when the flow enters the lower lying areas in the floodplains. These lower lying areas are wider than the side channels that connect them to the main channel. So, the width of the side channel essentially increases here, which decreases flow velocities and thus causes deposition of sediment in these parts of the side channels. Oppositely, the riparian channels of LTDs remain more or less constant in width.

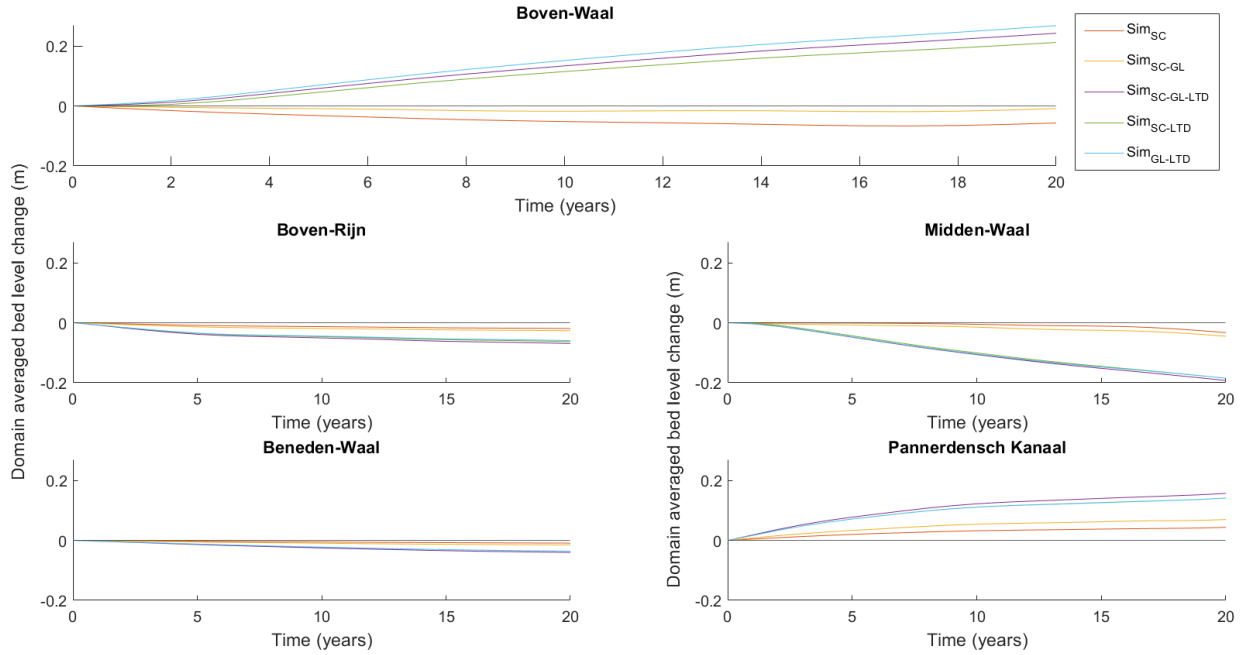

FIGURE 4.18: Domain averaged bed level change per river branch compared to Sim_{REF} after 20 years.

4.2.4 Analyses of the effects on the consequences of bed degradation for all simulations

To answer the third research question, the impact of the different combinations of river interventions on the consequences of bed degradation are visualized. This will show if the different combinations of river interventions are actually helping in moving towards the goals of IRM, these goals being, safe navigation, high water safety and among others, fresh water availability. These goals will be assessed by visualizing water depths at low discharge, water levels at high discharge and the discharge distribution at the Pannerdensch Kop.

Ship navigation

If the bed degradation is not stopped, the fixed layer at Nijmegen and the river bed groynes at Erlecom will become increasingly worse bottlenecks for ship navigation. The surrounding bed level will erode deeper into the landscape, while the bed level at these bottlenecks stays in place. This can cause insufficient water depths for ship navigation during low discharges.

Figure 4.19 shows the cross-sectional averaged water depth along the Boven-Waal at OLA (1020 m^3/s). It can be seen that the water depth is already insufficient for Sim_{REF} after 20 years, when comparing with the norm for ship navigation, which is a width averaged water depth of 4 meter (Rijkswaterstaat WVL, 2019). None of the simulations are actually able to comply with this norm.

Sim_{SC} and Sim_{SC-GL} lead to slightly improved water depths along the Boven-Waal compared to Sim_{REF} , except at the Kaliwaal (rkm 873-874.5) and Bizonbaai (rkm 876-879), which are already activated at OLA. So, here water depths are decreased compared to Sim_{REF} .

$Sim_{SC-GL-LTD}$, Sim_{GL-LTD} and Sim_{SC-LTD} show that the inclusion of LTDs decreases width-averaged water depths at almost all locations along the Boven-waal after 20 years. This is partially caused by the slope of the LTD crest that extends into the main channel. Besides, the LTDs cause the sedimentation pattern in the inner bends of the Boven-Waal to be located closer to the centre

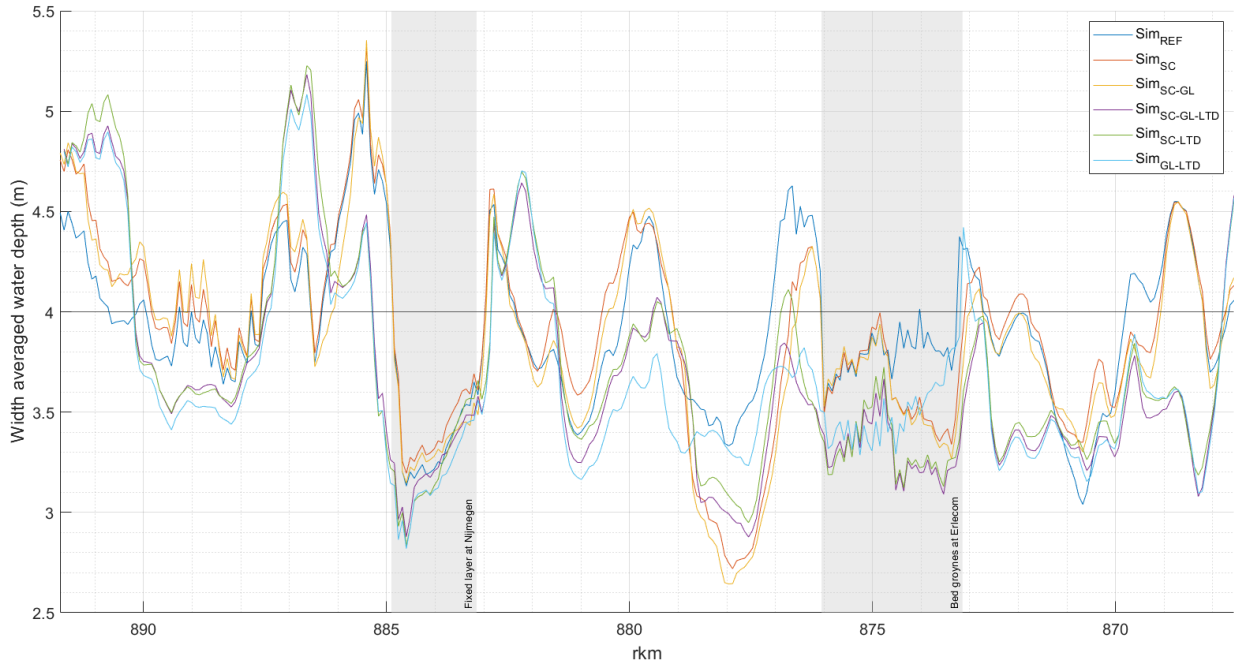

FIGURE 4.19: Width averaged water depth during OLA ($1020 \text{ m}^3/\text{s}$) after 20 years along the Boven-Waal for the different simulations. The black horizontal line indicates a width averaged water depth of 4 meter that needs to be ensured (Rijkswaterstaat WVL, 2019).

of the main channel and thus width averaged water depths will be influenced. This inner bend sedimentation is clearly visible in Figure 4.20, which shows whether or not a water depth of 2.8 meter is achieved after 20 years, as this is required for ship navigation (Rijkswaterstaat WVL, 2019).

Figure 4.20 also shows that there is still a navigation channel with sufficient water depth present at the end of Sim_{GL-LTD} , except at the fixed layer at Nijmegen. This is actually true for all simulations. Only Sim_{REF} ensures a minimum water depth of 2.8 meter over the fixed layer at Nijmegen. Even though it seems that Sim_{SC} and Sim_{SC-GL} in Figure 4.19 improve the width averaged water depth over the fixed layer, this only happens due to erosion in the erodible inner bend at the fixed layer (Figure 4.15), causing width averaged water depths to increase via a decrease in bed level, without actually improving the water depth over the fixed layer itself. The same is true for the others simulations with LTDs, the slope of the LTD crest and the sedimentation close to this slope cause higher width averaged bed levels in the erodible inner bend at the fixed layer (Figure 4.15) and thus lower width averaged water depths here.

A better picture of the situation is obtained by looking at the actual water depth over the fixed layer itself, instead of the whole main channel width. Figure 4.21 shows that when averaging the water depths above the fixed layer itself, Sim_{SC} and Sim_{SC-GL} actually worsen the water depths above the fixed layer. $\text{Sim}_{SC-GL-LTD}$, Sim_{GL-LTD} and Sim_{SC-LTD} arguably lead to no overall improvement, as the water depths above the fixed layer are better at the upstream part of the fixed layer and worse at the lower part of the fixed layer. Still, the width averaged water depths above the fixed layer are far from the 4 meter that needs to be ensured for safe ship navigation according to Rijkswaterstaat WVL (2019).

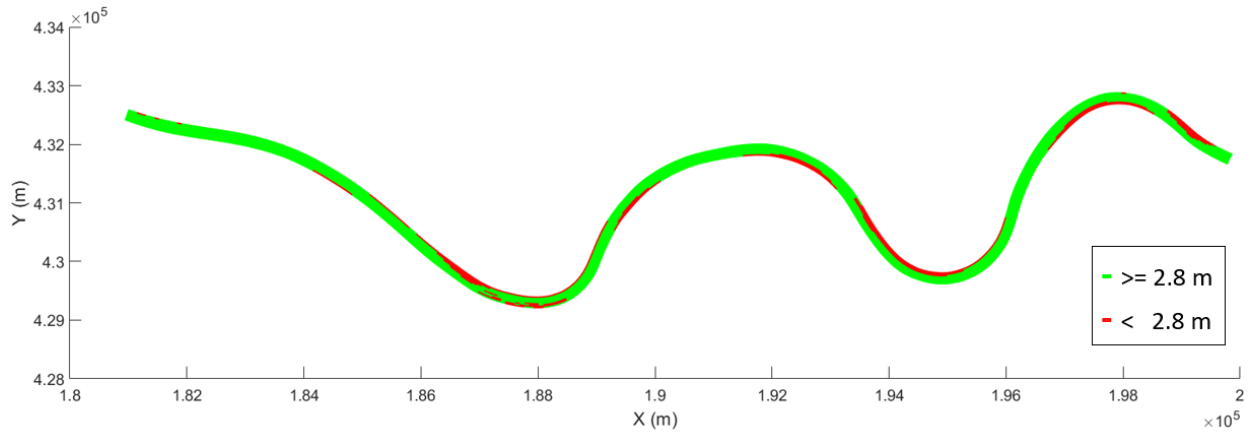

FIGURE 4.20: Water depth during OLA ($1020 \text{ m}^3/\text{s}$) after 20 years along the Boven-Waal for Sim_{GL-LTD} . Red indicates a water depth below 2.8 meter and green indicates a water depth above or equal to 2.8 meter, which needs to be ensured (Rijkswaterstaat WVL, 2019).

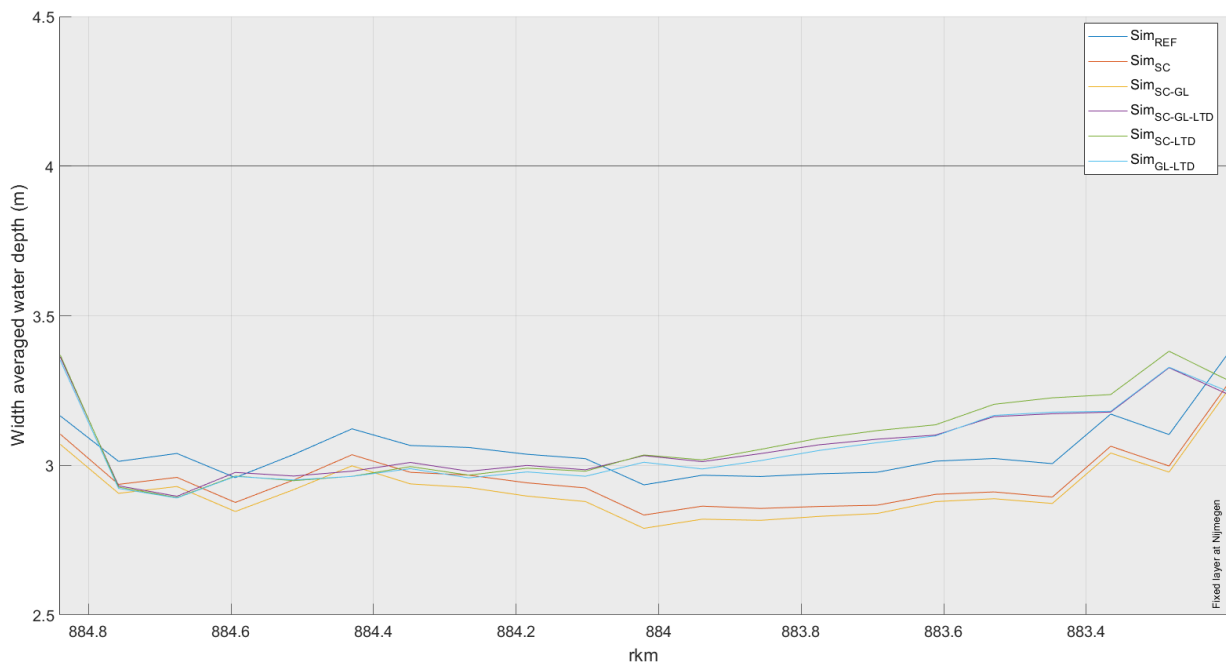

FIGURE 4.21: Width averaged water depth during OLA ($1020 \text{ m}^3/\text{s}$) over the fixed layer after 20 years for all simulations. The black horizontal line indicates a width averaged water depth of 4 meter that needs to be ensured (Rijkswaterstaat WVL, 2019).

Flood protection

To assess the effectiveness of the different simulations in improving flood protection, the width averaged water levels during a discharge of 7009 m³/s are visualized in Figure 4.22.

It can be seen that the width averaged water levels are lowered in the upstream section of the Boven-Waal and increased in the downstream section of the Boven-Waal during a discharge of 7009 m³/s after 20 years of morphological simulation. However, the upstream lowering of high water levels is larger than the downstream heightening of high water levels. More river interventions lead to lower high water levels in the upstream section, but it comes at the cost of larger high water levels in the downstream section. Though this increase in high water levels downstream seems to go in a slower pace than the decrease in high water levels upstream. This increase in water levels in the downstream section is expected, as upstream river widening always leads to an increase in water levels downstream of the river widening. This increase is also known as the 'Benedenstroomse piek' or downstream peak (Rijkswaterstaat WVL, 2019). It is caused by the water level reacting slower than the acceleration of the flow after a river widening measure.

Sim_{SC} captures these downstream peaks best, as it does not include side channels and summer dike lowering in the downstream section of the Boven-Waal. Whereas the other four simulations do include river interventions in the downstream section of the Boven-Waal. Every side channel in Sim_{SC} causes a downstream peak, except they are compensated again by the next downstream side channel, until there are no side channels anymore downstream from rkm 883. The Oude Waal (rkm 881.5-883) is not capable of compensating for the downstream peak induced by the other upstream side channels. When comparing Sim_{SC} and Sim_{SC-GL}, the addition of groyne lowering in Sim_{SC-GL} lowers high water levels even more in the upstream part of the Boven-Waal, while slightly delaying and heightening the downstream peak in the downstream part of the Boven-Waal.

The other simulations (Sim_{SC-GL-LTD}, Sim_{SC-LTD} and Sim_{GL-LTD}) that include LTDs also eventually cause increased high water levels compared to the reference situation in the downstream section of the Boven-Waal. Even though large-scale river widening has been implemented in this downstream section of the Boven-Waal, it is not enough to compensate for the downstream peak induced by the interventions that are implemented in the upstream section of the Boven-Waal. The downstream peaks at the end of the Boven-Waal quickly subdue in the Midden-Waal, as no more river widening interventions are implemented here.

Looking at the complete image, Sim_{GL-LTD} seems to improve flood protection the most, as it almost leads to an overall decrease in high water levels along the whole Boven-Waal. Besides, it causes the most lowering of high water levels in the upstream section of the Boven-Waal, at the cost of a relatively small downstream peak in the downstream section of the Boven-Waal. However, it can also be argued that Sim_{SC} gives more favourable high water levels, as it also provides lower water levels in the upstream section, while keeping the absolute height of the downstream peak small.

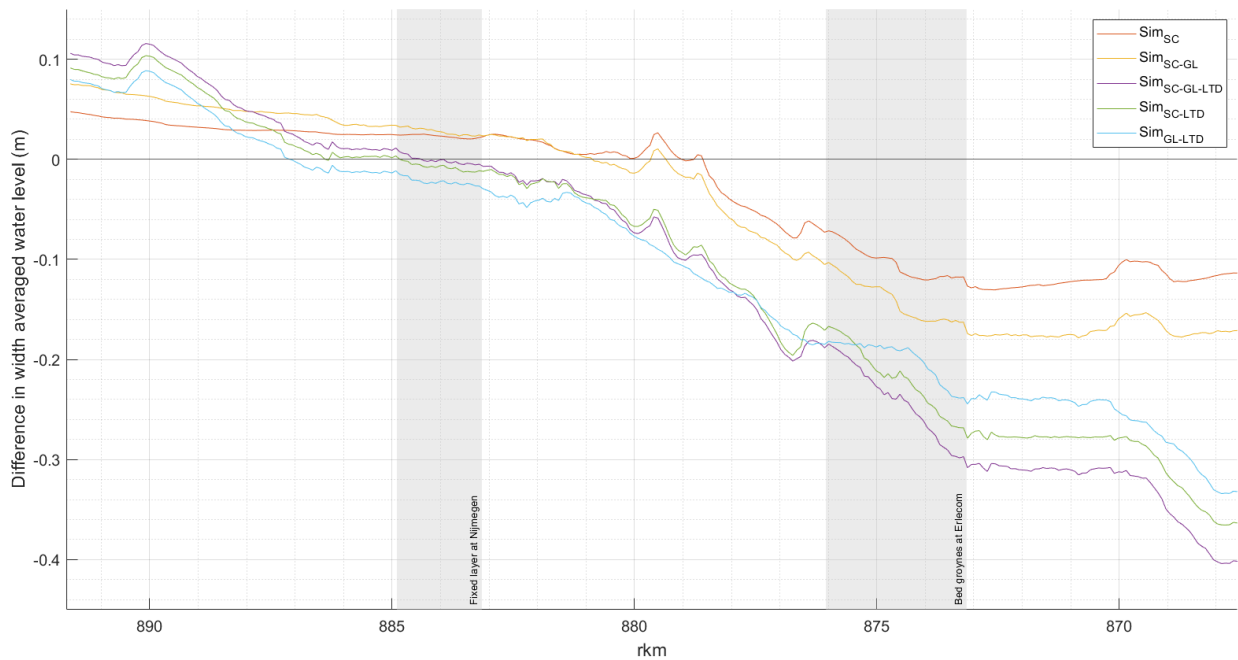

FIGURE 4.22: Width averaged water level during a discharge of $7009 \text{ m}^3/\text{s}$ after 20 years for all simulations. The values are compared to the water levels at the end of Sim_{REF} . Positive values indicate increased high water levels compared to Sim_{REF} and negative values indicated decreased high water levels compared to Sim_{REF} .

Fresh water availability

In order to ensure that sufficient discharge flows into the largest fresh water source of The Netherlands, the IJsselmeer, the discharge distribution at the Pannerdensch Kop should be shifted more towards the Pannerdensch Kanaal during the lower discharges, hereby ensuring fresh water availability for the future.

Figure 4.23 and 4.24 show the discharge distribution at the Pannerdensch Kop at the end of all simulations. The general pattern visible in Figure 4.23 is that for higher discharges, the discharge distribution at the Pannerdensch Kop skews more towards the Boven-Waal, as more river widening measures are implemented. This is logical, as the river interventions are only implemented in the Boven-Waal, without performing any river widening interventions in the Pannerdensch Kanaal. So, the flow upstream of the river widening interventions will accelerate and attract more flow towards the (Boven-)Waal.

Figure 4.23 also shows that the simulations that include LTDs ($\text{Sim}_{SC-GL-LTD}$, Sim_{SC-LTD} and Sim_{GL-LTD}) have a discharge distribution at the Pannerdensch Kop that developed in a similar way. The same is true for Sim_{SC} and Sim_{SC-GL} .

First, the discharge distribution is addressed for the runs that include LTDs. This will be done going from low discharges to high discharges. It can be noticed that the simulations that include LTDs ($\text{Sim}_{SC-GL-LTD}$, Sim_{SC-LTD} and Sim_{GL-LTD}), cause more discharge to flow to the Pannerdensch Kanaal, during the low discharges of $1020 \text{ m}^3/\text{s}$, $1294 \text{ m}^3/\text{s}$ and $1543 \text{ m}^3/\text{s}$. This happens due to the fact that the LTDs essentially narrow the main channel prior to their sills being overflowed. Once their sills are overflowed from an upstream discharge of $1543 \text{ m}^3/\text{s}$ onwards, the simulations including LTDs start to attract a larger portion of the discharge to the (Boven-)Waal, compared to Sim_{REF} . What is interesting about the development of the discharge distribution of the simula-

tions that include LTDs, is that even though the sills of the LTDs already overflow for an upstream discharge of 1543 m³/s, the Boven-Waal still attracts less discharge than in the reference situation after 20 years for this discharge level. At the start of the simulations with LTDs, the Boven-Waal immediately attracts more discharge than in Sim_{REF} for an upstream discharge of 1543 m³/s. However, the sedimentation in the main channel caused by the LTDs after 20 years seems strong enough to counter this initial effect and even causes additional flow to the Pannerdensch Kanaal during an upstream discharge of 1543 m³/s, compared to Sim_{REF}.

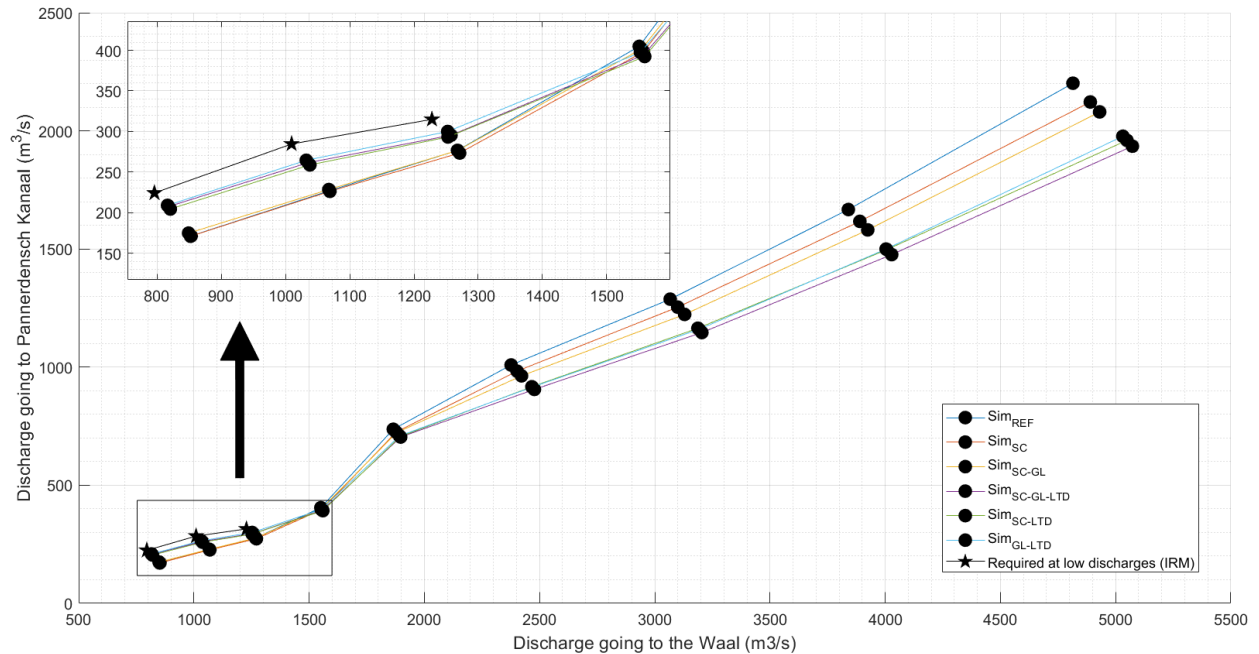

FIGURE 4.23: The discharge distribution at the Pannerdensch Kop over the Boven-Waal and the Pannerdensch Kanaal after 20 years. All simulations are shown. The upstream steady discharge steps at which data is available can be recognized by the nine clusters of black dots. From left to right, these upstream discharges are 1020 m³/s, 1294 m³/s, 1543 m³/s, 1954 m³/s, 2601 m³/s, 3384 m³/s, 4353 m³/s, 5506 m³/s and 7009 m³/s.

Second, Sim_{SC} and Sim_{SC-GL} also show a similar development of the discharge distribution in Figure 4.23. It can be noticed that these simulations show small differences with Sim_{REF} during the low discharges of 1020 m³/s, 1294 m³/s and 1543 m³. When looking at Sim_{SC} and Sim_{SC-GL} at OLA (1020 m³/s) in Figure 4.24, it can be noticed that the sedimentation in the upstream section of the Boven-Waal in both simulations seems to cause a slight shift in discharge towards the Pannerdensch Kanaal, even though only river widening side channels are implemented in the Boven-Waal. Additionally, something interesting can be seen about the addition of groyne lowering. For the lower discharges (1020 - 1543 m³/s), Sim_{SC-GL} seems to cause additional flow towards the Pannerdensch Kanaal, compared to Sim_{SC}. So apparently, the increase in bed level of the main channel after 20 years induced by groyne lowering is stronger than its river widening effect for these discharges. So as long as the increase in bed level does not cause the groynes to overflow for a lower upstream discharge, groyne lowering in the Boven-Waal directs more discharge towards the Pannerdensch Kanaal. Lastly, for the higher discharges (1954 m³/s - 7009 m³/s), the (Boven-)Waal simply starts to attract more discharge for both Sim_{SC} and Sim_{SC-GL}, compared to Sim_{REF}.

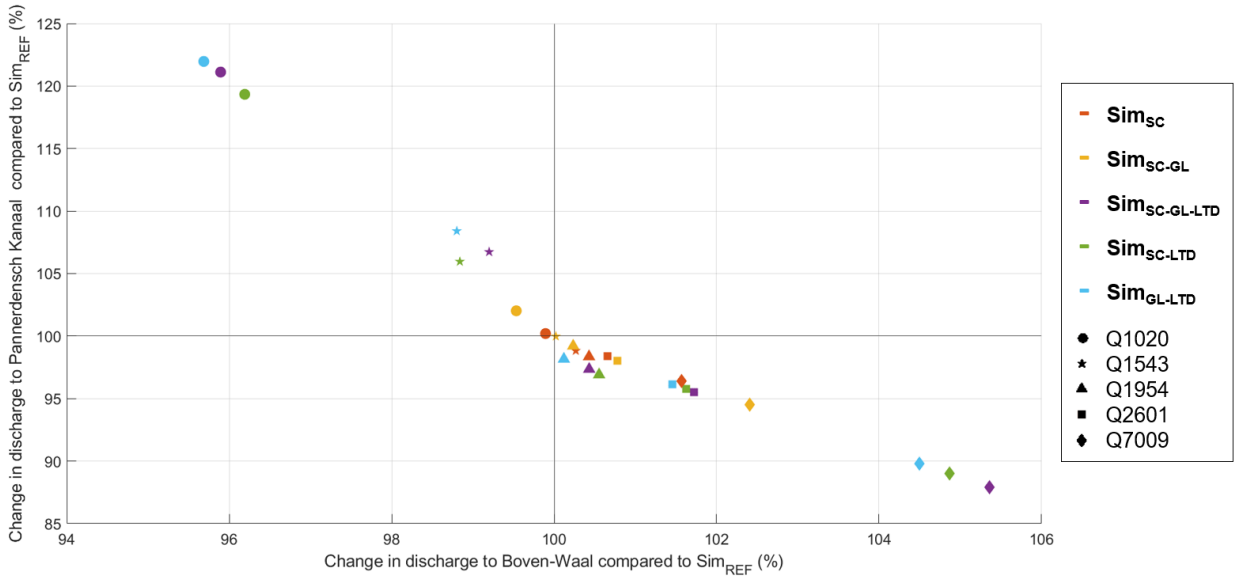

FIGURE 4.24: Percent change in discharge going to the Boven-Waal and Pannerdensch Kanaal at the Pannerdensch Kop compared to Sim_{REF} after 20 years. Each simulation has its own colour and each upstream discharge has its own marker type. The upstream left quadrant indicates that more discharge is flowing towards the Pannerdensch Kanaal compared to Sim_{REF} . The lower right quadrant indicates that more discharge is flowing towards the Boven-Waal compared to Sim_{REF} .

Now to ensure future fresh water availability, the 'Program under environmental Law IRM' prescribes the desired discharge distribution over the Dutch Rhine branches at lower discharges. At low discharges, at least 22% of the Boven-Rijn discharge has to flow into the IJssel (Programma Integraal Riviermanagement, 2023). Besides, during decreasing discharges, at least 285 m^3/s has to flow through the IJssel and 30 m^3/s has to flow through the Neder-Rijn, for as long as possible, up to a discharge of 1,300 m^3/s at Lobith (Programma Integraal Riviermanagement, 2023). So, as the Pannerdensch Kanaal bifurcates into the Neder-Rijn and IJssel (Figure 1.2), it certainly needs to get 22% of the discharge in the Boven-Rijn during low discharges (1020 m^3/s and 1294 m^3/s in Figure 4.23) and depending on the discharge division at IJsselkop, even more. Besides, during decreasing discharges (1543 m^3/s in Figure 4.23), at least 315 m^3/s has to flow into the Pannerdensch Kanaal. This requirement for the lower discharges that has been outlined in this paragraph is also visible in Figure 4.23.

When calculating these percentages for the 1020 m^3/s and 1294 m^3/s discharges, $Sim_{SC-GL-LTD}$, Sim_{SC-LTD} and Sim_{GL-LTD} establish a discharge distribution that directs about 21% of the total Boven-Rijn discharge to the Pannerdensch Kanaal, which is still 1% short of the desired discharge distribution during low discharges. Whereas, Sim_{REF} , Sim_{SC} and Sim_{SC-GL} only direct about 17% to the Pannerdensch Kanaal during the discharges of 1020 m^3/s and 1294 m^3/s . Similarly, during an upstream discharge of 1543 m^3/s , the simulations including LTDs are only capable of directing about 300 m^3/s of discharge towards the Pannerdensch Kanaal, which is still 15 m^3/s short of the desired discharge distribution. For the other simulations without LTDs, this is only 275 m^3/s , so 40 m^3/s short of the desired discharge distribution during a discharge of 1543 m^3/s .

What can be concluded from Figure 4.23 and 4.24, is that the implemented LTDs have by far the largest influence on the discharge distribution at the Pannerdensch Kop. Although none of the simulations comply with the desired discharge distribution at low discharges defined in IRM, the simulations that include LTDs ($Sim_{SC-GL-LTD}$, Sim_{SC-LTD} and Sim_{GL-LTD}) cause a considerable shift in the right direction. From these simulations that include LTDs, Sim_{GL-LTD} seems to

always lead to more flow towards the Pannerdensch Kanaal than $\text{Sim}_{SC-GL-LTD}$ and Sim_{SC-LTD} , which also makes it come closest to the desired discharge distribution at the Pannerdensche Kop described by IRM. Moreover, what is interesting is that even though the applied river interventions essentially widen the Boven-Waal and thus intuitively should attract more discharge once they are activated, the sedimentation induced by river interventions can also have a considerable effect on the discharge distribution and may even cause additional flow towards the Pannerdensch Kanaal during the discharges for which the river interventions are activated. Lastly, when simultaneously looking at Figure 4.18 and 4.24, it can be seen that the additional flow towards the Pannerdensch Kanaal for the lower discharges does not lead to additional erosion there. This again shows that the medium discharges are dominant when attempting to govern the morphology of a river. Figure 4.4 showed that the most influential upstream discharge on morphology is $1954 \text{ m}^3/\text{s}$. Figure 4.24 shows that from this discharge onwards, the Waal attracts additional discharge compared to Sim_{REF} , which is seemingly enough to still cause sedimentation in the Pannerdensch Kanaal. Even though it gets a large amount of additional discharge during low discharges.

5 | Discussion

This chapter will reflect on the presented results and the methods used to get to these results. Comparisons will be made to other studies in order to establish similarities and differences. The most important findings in the results and the reliability of the results will be addressed. First, a synthesis of the results is presented. Followed by a reflection on the methodology.

5.1 Synthesis of the results

This section essentially provides answers to the three sub-research questions. The first sub-research question is addressed by summarizing the most important findings about the implemented starting package of low effort (re)construction of side channels and the lowering of summer dikes. Insights are given into how the findings of this research can be combined with the findings of other studies. The same will be done for different combinations of this starting package of river interventions, groyne lowering and longitudinal training dams, hereby providing an answer to the second sub-research question. Lastly, the effects of the different combinations of river interventions on the consequences of bed degradation will be summarized, which answers the third sub-research question.

5.1.1 The maximum achievable mitigation of bed degradation via low effort side channel (re)construction and summer dike lowering

This research aimed to use lower lying areas in the floodplains as a starting point in countering bed degradation. Side channels could easily be created by connecting these lower lying areas to the main channel. By making the bed level of these side channels equal to the absolute height of these lower lying areas, the maximum potential of these type of side channels in countering bed degradation is unveiled.

Starting out from low effort side channels (re)construction and summer dike lowering (Sim_{SC}) caused local sedimentation and an overall increase in erosion in the Boven-Waal, compared to the reference simulation. Sim_{SC} only seems to hint at an improvement upon the reference situation after more than 20 years, merely judging by the stabilizing trend in the last few years of simulation.

So, the maximum achievable mitigation of bed degradation via low effort side channel (re)construction and summer dike lowering is not the optimal situation. Connecting lower lying areas in the floodplains at their elevation to the main channel causes activation of the side channels for upstream discharges that are undesirable. Side channels which only activate at a discharge of $2601 \text{ m}^3/\text{s}$ or higher were not able to reverse the ongoing erosion trend in the Boven-Waal. Oppositely, side channels that are already activated at OLA ($1020 \text{ m}^3/\text{s}$) are capable of reversing the ongoing erosion trend into a sedimentation trend over the length over which the side channels are active, compared to Sim_{REF} . However, the local effects of these side channels that activate at OLA are undesirable, as they may cause navigation problems, which again calls for additional dredging (Klijn et al., 2022). Therefore, it would be better for all the side channels in this research to be activated for medium discharges ($1543 - 1954 \text{ m}^3/\text{s}$ in the DVR model).

The large bends in the Boven-Waal make implementation of side channels difficult, as when the inflow and outflow of side channels are located in inner bends, it leads to unfavourable results. Secondary flow causes a considerable amount of sediment to end up in the inflow of side channels in inner bends. This sediment is then deposited on the bed of the side channels, which reduces the sediment availability in the downstream section of the Boven-Waal. This confirms findings based on real-life observations of van Denderen et al. (2019a), who found that spiral flow causes a near-bed flow velocity that has a different direction compared to the depth-averaged velocity, which in turn causes more sediment to be directed into the side channel. So, the corrections applied to the depth-averaged equations of the DVR model to capture spiral flow seem to function well. Oppositely, secondary flow causes aggravated local scour at the outflow of side channels in inner bends. This seems to be less of an issue in outer bends, but it can not be confirmed with the outcomes of Sim_{SC}, due to outflow of two outer bend side channels being located at fixed layers and the fact that the other two outer bend side channels activate at higher discharges. Additionally, due to the implemented side channels, the gradient between the upstream and downstream section of the Boven-Waal is increased, which increases bed degradation in the downstream section of the Boven-Waal. This results from the fact there are no possibilities for the connection of lower lying areas via side channels in the downstream section of the Boven-Waal. So, a chain of side channels, as recommended by Oldenhof (2021) and Welsch (2021), can thus not be created in the winter bed of Boven-Waal. These results do not provide justification for the implementation of low effort side channel (re)construction in the Boven-Waal.

The effect of the lowering of summer dikes that was combined with the implementation of side channels, seems to be too small to consider implementing. The results showed that only the lowered summer dikes in the Bemmelse Waard and to a much smaller extent the floodplain of the Oude Waal seem to have an influence on the fraction of flow through the floodplains at a discharge of 7009 m³/s. The effect on the main channel bed was impossible to entangle from the effect of side channels, as the summer dikes and side channels are often active over the same length. It should be noted that the highest discharge in the used hydrograph is 7009 m³/s, which occurs approximately once every 3 years in reality. It could very well be that lowering of summer quays has positive effects on even higher discharges that were not considered in the performed simulations. Besides, it seems likely that lowered summer dikes can ensure frequent activation of the floodplains in the upstream section of the Boven-Waal, as the side channels extract discharge from the main channel, which directly causes lower water levels, which are even lower due to the erosion that is ongoing throughout Sim_{SC}. It seems inevitable to also lower the summer dikes, to keep the frequency of floodplain inundation high. So, even though the results of this study do not show proof for the effectiveness of lowering summer dikes, it should not be written off.

5.1.2 The mitigation of bed degradation for different combinations of river interventions

Different combinations of side channel (re)construction and summer dike lowering, groyne lowering and longitudinal training dams have been researched. By the addition and exclusion of these river interventions per simulation, their effectiveness in mitigating ongoing bed degradation is shown. The results show that there is potential for certain combinations of river interventions to mitigate bed degradation in the Boven-Waal.

In the reference run, erosion in the Boven-Waal continues for at least 20 years. Given that the erosion trend does not seem to stabilize after 20 years, it suggests that a morphological equilibrium is still not close to being reached after 20 years of simulation. Opposite to the reference simulation, all the other performed simulations seem to have stabilizing trends towards the end of the simulation. Indicating that all combinations of river interventions that were researched, help in stabilizing the erosion trend after 20 years. Nevertheless, in all simulations, the Boven-Waal is still

adjusting towards a morphological equilibrium as a reaction to the change in hydraulics, which are induced by the river interventions. So sedimentation and erosion waves are still moving through the system. Welsch (2021) has shown that the river bed still adapts to the change in hydrodynamic conditions induced by implemented river interventions after 20 years of simulation. He performed a simulation with a duration of 50 years, in which river interventions from the Room for Living Rivers vision were implemented. His results show that the implemented river interventions only caused a net sedimentation rate after 25 years, in the river bed over which the interventions are implemented. Downstream of the river interventions, initial induced erosion pits seem to be filled up with sediment only after about 45 years of morphological simulation. Therefore, the results of this research do provide an insight into their potential in countering bed degradation, but on a longer term, other simulations may stand out as more promising than in the current results. Still, this reaction to the changed hydraulic conditions is a relaxation process (Sieben, 2010), so a substantial part of the morphological reaction of the Boven-Waal should have already been captured after 20 years.

From the results it becomes clear that more river interventions do not directly lead to better overall performance. Section 5.1.1 already explained that the performed implementation of side channels in the Boven-Waal (Sim_{SC}) shows more bed degradation than Sim_{REF} . This is also true for Sim_{SC-GL} , but it seems to already perform better than Sim_{SC} , as groyne lowering caused additional sedimentation in the upstream section of the Boven-Waal, while not aggravating the erosion in the downstream section of the Boven-Waal. The effects of groyne lowering are positive in the Boven-Waal, as they always led to approximately 4 to 5 centimeter less erosion or additional sedimentation in the main channel over 20 years of simulation. Although the effects of groyne lowering are small, compared to side channels and LTDs, they are already continuously present along the Dutch Rhine branches, which enables a more gradual effect on the bed level of the main channel, similar to LTDs. Besides, the fact that they are already in place, makes it a relatively easy river intervention to implement. Given that groyne lowering is influencing the flow for medium discharges, it is a small, yet effective measure to combine with other river interventions.

Similar to groyne lowering, LTDs can also be continuously implemented along the Boven-Waal. LTDs are a more drastic river intervention to implement, but they also seem to pay off in the long-term. Compared to side channels, LTDs seem to be capable of inducing both larger and more evenly spread out effects over the Boven-Waal. All three simulations that include LTDs ($\text{Sim}_{SC-GL-LTD}$, Sim_{SC-LTD} and Sim_{GL-LTD}) start to cause domain averaged sedimentation after 4 years of simulation, while the simulations that include side channel (re)construction and summer dike lowering always led to relatively more erosion, due to the increased gradient between the upstream and downstream section of the Boven-Waal. This net sedimentation rate is similar to the net sedimentation rate of the pilot LTDs near Tiel, which showed a net sedimentation rate after 5 years (Czapiga et al., 2022). Compared to side channels, LTDs are also not as limited by the available space in the floodplains of the Boven-Waal, which was a limitation for the implementation of side channels in the downstream section of the Boven-Waal. However, just as for side channels, the LTDs in this research should activate for higher discharges than they did in this research. Based on the results, it also seems that the LTDs in the downstream section of the Boven-Waal become less effective over time, which seems to be a reoccurring problem for some LTDs in other studies (e.g. Pfeijffer, 2023; Sloff et al., 2023b).

Figure 4.15 actually showed that the river interventions in Boven-Waal induce considerable sedimentation, especially in the upstream section of the Boven-Waal. Morphological effects on the bed are in the order of 0.5 to 1 meter. These are large effects on the bed level. It seems that it would be better to let river interventions in the upstream section of the Boven-Waal induce less sedimentation (e.g. ± 0.2 meter after 20 years) in the main channel, such that downstream ero-

sion will also be less, hereby bringing both the bed level change in the upstream and downstream section closer to each other, which reduces the gradient and improves the complete functioning of the Boven-Waal as a whole. This reduction of the dimensions of upstream river interventions could cause both side channels and LTDs to perform better.

There seems to be another option for LTDs to get better performance, as in contrary to side channels, they are also present in the downstream section of the Boven-Waal. As mentioned, the absolute effect on the main channel bed of the LTDs seems to be approximately 1 meter of sedimentation. To bring the bed level change in the upstream section and downstream section closer to each other, the dimensions of LTDs could be gradually increased when going downstream. Thus starting with LTDs with higher sills and crests and/or smaller riparian channels upstream, to LTDs with gradually lower sills and crests and/or wider riparian channels when moving downstream. This could also be done for groyne lowering, even though the effects would be way smaller. So, groynes should then gradually decrease in height when moving downstream.

To conclude, from a morphological perspective, a combination of groyne lowering and LTDs (Sim_{GL-LTD}) seems most effective in the Boven-Waal, as it reduces overall bed degradation the most, while simultaneously leading to the smallest gradient between the upper and downstream section of the Boven-Waal. However, if a combination of LTDs and groyne lowering is applied in reality, it seems to be necessary to implement them across the whole Waal, such that additional downstream erosion is reduced. For all morphological results, it should be noted that different simulations might look more promising if river widening is also applied in the Pannerdensch Kanaal. If river widening is applied in the Pannerdensch Kanaal, more discharge will flow towards the Pannerdensch Kanaal. This in turn causes the flow velocities at river interventions in the Boven-Waal to reduce even more, which leads to more sedimentation over the length at which the river interventions are active in the Boven-Waal. This shows that the morphological situation in the Dutch Rhine branches is always a fine balance between the actions undertaken in the different branches. Lastly, it should be noted that adaptive sediment management remains necessary during the time in which the river interventions are build. Initial reactions are always strong and lead to pressing problems, which can only be countered in the short-term by adaptive sediment management (Sloff et al., 2023b).

5.1.3 Effects of the different combinations of river interventions on the consequences of bed degradation

The conclusion on the effect of the different combinations of river interventions on flood protection after 20 years is relatively simple. In general, the implementation of river widening measures in the Boven-Waal leads to a reduction in high water levels in the upstream section of the Boven-Waal, while causing increased water levels in the downstream section of the Boven-Waal. The wider the river gets due to the implemented river interventions, the higher the downstream peak will be. So, logically $\text{Sim}_{SC-GL-LTD}$ has the largest reduction in water level upstream, while also having the largest downstream peak. The downstream peak will continue to shift further downstream provided that the river interventions implemented downstream can compensate for the peak. This compensation of the downstream peak might be possible in the Boven-Waal, if the previously described method of increasing the dimensions of river interventions when moving downstream is applied. This way, it might be controlled where the downstream peak will occur.

As for fresh water availability, it requires directing more discharge at the Pannerdensch Kop towards the Pannerdensch Kanaal during lower discharges. Only the combinations of river interventions that include LTDs can considerably influence the discharge distribution at the Pannerdensch Kop during low discharges, but none of the simulations is able to fully comply with the desired discharge distribution during low discharges as defined in 'Programma Integraal Riviermanagement'

(2023). Still, Sim_{GL-LTD} comes very close to this desired discharge distribution after 20 years of simulation.

No combination of river interventions has managed to enhance the navigability of the Boven-Waal after 20 years. Despite the presence of a clear navigation channel throughout the Boven-Waal in all simulations, all river intervention combinations result in inadequate water depth over the fixed layer at Nijmegen. The reference simulation maintained a minimum water depth of 2.8 meter at this fixed layer, but the reduced discharge flowing through the Boven-Waal during OLA renders this unachievable for simulations incorporating LTDs. This seems to be a general effect of implementing LTDs in the Boven-Waal (Pfeijffer, 2023). Conversely, simulations excluding LTDs suffer from insufficient water depth due to increased erosion of the bed around the fixed layer.

So, the impact of the different combinations of river interventions on reducing the consequences of bed degradation confirms the need for a well-defined plan for the Dutch Rhine branches prior to any action. This is crucial due to the delicate balance required between maintaining the navigability of the Boven-Waal and ensuring additional discharge to the Pannerdensch Kanaal during low discharges to secure adequate fresh water supply. When implementing hard river interventions, it should be certain that they are no-regret measures.

5.2 Reliability of the used methodology

In this section, the limitations that were encountered while using the DVR model will be discussed. Followed by an assessment of the model output of the reference simulation using the intermediate version of the DVR model, compared to the model output of the reference simulations of both the old and new version of the DVR model. Here, comparisons will also be made with morphological trends of other studies.

5.2.1 Limitations of the DVR model

The DVR model provided a tool for investigating the effects of a range of different combinations of river interventions. However, it has to be acknowledged that it also has its limitations. The main limitations encountered in this study are outlined in this section.

Coarse grid size

One of the important limitations is that the grid of the DVR model is quite coarse, especially in the floodplains. This leads to a coarse implementation of river interventions in the floodplains. Besides, the actual present situation in the floodplains is also not fully captured, which may result into quite different outcomes at high discharges, in which large parts of the floodplains are overflowed. The large grid cells require a single value for all input files that is representative for the whole surface area of the grid cell. For example, roughness and bathymetry values are simply averaged over the whole surface area of the grid cell. This causes the model to not accurately describe the actual situation in the floodplains. For instance, when connecting the lower lying areas in the floodplains to the main channel via side channels, some roughness and bathymetry data had to be changed, as these lower lying areas were often part of a larger grid cell that also includes higher lying areas. This logically leads to a higher average bed level in the cell and a roughness value that does not correspond with the actual situation.

The same is true for weirs. Contour lines that indicate a change in height in Baseline are simply snapped to the edges of the grid cells in which they are located (Appendix D). These contour

lines do not follow the edges of the grid cells and sometimes it is difficult to determine which weir corresponds to which feature in the floodplains in Baseline. This could indicate that the model strays from reality significantly at locations with a coarse grid size. Additionally, a coarse grid size also limits the amount and preciseness of river interventions that can be implemented in the model. Ideally, the performed groyne lowering in this research was combined with groyne extension. Groyne lowering initially causes lower water levels, as the river bed has not yet reacted to the change in hydrodynamics. If combined with groyne extension, this can be prevented (Ouwerkerk et al., 2023). Besides, groyne extension would also have caused less discharge to flow to the Waal at the Pannerdensche Kop, as the summer bed is essentially narrowed, which is desired based on the goals of IRM. This could not be investigated, as extension of the groynes immediately meant that the groynes would be extended by about 15 to 25 meter on either side of the main channel, depending on its location in the Boven-Waal.

For the same reasons, the width of a riparian channel of an LTD in this research could either be increased by approximately 42 meter or decreased by approximately 30 meter. There is no in between option without completely relocating the LTD. So, the options of where to implement LTDs on the grid are limited. These problems have also been encountered in previous research of Pfeijffer (2023) and Welsch (2021). Pfeijffer (2023) experienced the exact same problem as described above about the LTD riparian channel width. Pfeijffer (2023) tried to optimize LTD designs by varying the dimensions of the crest, sill and width of the riparian channel. Due to the coarse grid, changing the width of the riparian channel is directly the most radical alteration to the LTD design. Therefore, it may come as no surprise that this schematization came out on top as most influential on the LTD design. Similarly, Welsch (2021) could not directly implement the design of the Room for Living Rivers vision, as the side channel widths would simply become larger and more varied in width than the Room for Living Rivers vision intended. Therefore, Welsch (2021) chose to locate the side channels closer to the main channel, which logically has consequences on the functioning of the side channel. Longer side channels attract relatively less discharge due to its length, which reduces bed shear stresses and thus causes more deposition of fine sediments (van Denderen et al., 2019a). Oppositely, in this research it was chosen to incorporate the larger grid cells in the floodplains, as the lower laying areas in the floodplains are meant to be more wide than the side channels connecting them to the main channel.

So the implemented river interventions in this research have been implemented in the best manner possible, but additional research with a finer grid is necessary to optimize the dimensions of the interventions before implementing them in reality. It should be noted that refinement of the grid goes hand in hand with an increase in computational time. So refinement should be refrained from until the effects of final designs need to be investigated, as computational times are already quite long.

Long computational times

The long computational times of the intermediate version of the DVR model limited the length of each simulation and the amount of simulations that could be researched. The duration of a single model run took about 7 to 9 days on a relatively powerful calculation PC, depending on the used spin-up period for the hydrodynamics and on the amount of simulations running simultaneously. In this research, most of the time two simulations were ran simultaneously. Even though both simulations slow each other down, the simulations were still finished faster than when performing single simulations after each other. The spin up of the hydrodynamics has the largest impact on the computational time, as this spin-up period is considerably longer than the period in which the morphological change is calculated.

Within this computational time, the model is able to simulate 20 years of morphological development. Ideally the simulations would have been performed for a longer duration, such that a morphological equilibrium is reached at the end of a simulation. This would have made the actual long-term impact of each combination of river interventions more clear than it currently is. However, this research was constrained by time, which prevented longer simulations. Some output hinted at a change in trend after about 20 years, such as the domain averaged bed degradation of each of the simulations (Figure 4.14).

Lastly, the long computational times also hindered the amount of simulations that could be performed during this research. Initially, more simulations were planned in order to gain more understanding about the cumulative effects of the different river interventions. Ideally, the individual effects of summer dike lowering, groyne lowering and LTDs would also be investigated by giving each of these river interventions a dedicated simulation. This way, the cumulative effects of individual river interventions could have been quantified better. Similarly, for summer dikes and side channels, dedicated runs for implementing them solely in either inner or outer bends were also planned, such that a better understanding of their two dimensional effects could have been inferred. Now, inferences could be made about this, but they are accompanied by considerable uncertainty.

Uncertainty related to the upstream boundary condition

Uncertainty in the incoming discharge at the upstream boundary directly translates to uncertainty in the resulting morphological development. The hydrograph that is used in the model is based on a calibration period from 2011 to 2020. Depending on the development of climate change in the future, incoming discharges at the upstream boundary could be either higher or lower. Although it is most likely that discharges in the river Rhine will increase in winter and spring and decrease in summer (Buitink et al., 2023), the uncertainty bounds for these future discharge scenarios are also wide, showing that almost any scenario can unfold. Seeing as IRM is about the functioning of the Dutch Rhine branches in the face of climate change, it is a limitation that climate change could not be included in the upstream boundary used in this study. Pfeijffer (2023) showed that the use of different climate change scenarios can result in considerable differences in the model output. Pfeijffer (2023) found that an increase in extreme discharges aggravates the bed degradation along the Waal, both with and without the implementation of LTDs. This is also likely to be true for the results of this research.

Lastly, the implementation of the upstream hydrograph in 9 steady steps also brings some additional uncertainty. As either the implemented river interventions are influencing the flow for a certain discharge or they are not. This makes the model more vulnerable to the chosen dimensions of implemented river interventions. For example, if a side channel would be activated for an upstream discharge of $3200 \text{ m}^3/\text{s}$ in reality, this side channel will only be activated for an upstream steady discharge of $2601 \text{ m}^3/\text{s}$ in the model, as a discharge of $3200 \text{ m}^3/\text{s}$ falls in between the upstream discharges of $2601 \text{ m}^3/\text{s}$ and $3384 \text{ m}^3/\text{s}$ in the upstream boundary condition. Even though in reality, the side channel would also be activated for the discharges in between $2601 \text{ m}^3/\text{s}$ and $3200 \text{ m}^3/\text{s}$. So in reality, this side channel would be activated for a longer duration of time and thus it would have more effect on the resulting hydraulics and morphodynamics. This causes a discrepancy between river interventions in reality and in the DVR model, which can not be solved by changing morphological scaling factors. Hereby inducing uncertainty about the actual effect of the modelled river interventions in reality, which makes translation of the results of this study to practice difficult.

Ship navigation

Other external forces that are not captured by the DVR model should be kept in mind when making direct comparisons between the model output and reality. An important example of such an external force is ship navigation. Sloff (2022) showed that variability between riverbed samples is partly caused by external forces, such as navigation. Hereby confirming the important impact that ship navigation has on the river bed composition. Ships that navigate upstream are loaded with cargo, whereas ships that navigate downstream are empty. Therefore, the ships that are moving upstream are heavier, which causes them to be closer to the riverbed and thus the flows generated by their bodies and propeller have a different impact on the riverbed (Sloff, 2022). Sloff (2022) found that the left side of the Waal with upstream navigation has a relatively fine bed compared to the right side of the Waal with downstream navigation, which has a relatively coarse bed composition. Implying that in reality, the left side of the Waal is more easily eroded than the right side of the Waal.

The DVR model can logically not reproduce these spatial differences in percentiles of grain diameters throughout the years of simulation. Therefore, it was chosen to exclude this effect of ship navigation on the bed composition by laterally averaging the samples of the bed composition (Sloff et al., 2023a). This also caused the natural sediment sorting caused in river bends to be absent. However, this is a natural process and thus the DVR model is capable of reproducing it. This sorting thus happens in the morphological spin-up of the model. Still, the cross-sectional differences in bed composition between model and reality induce uncertainty in the discrepancy between morphological development of the river bed in the DVR model and in reality.

Of course, most of the previous mentioned limitations of the DVR model are a result of simplification in order to reduce computational times, which has already been mentioned to be quite long. So even though it may seem like there many improvements to be made to the model, this should only be done once research moves from explorative preliminary designs to actual precise final designs of river interventions. Only then, the additional computational time might be worth it.

5.2.2 Reflection on the quality of the model output

It is important to remain vigilant about how the Dutch Rhine delta will actually develop in the future and if the DVR model reflects this, as this is directly related to the applicability of the results of this study. In order to gain confidence about the reliability of the model output, the reference simulation of the intermediate version of the DVR model is compared with the reference run of the old version of the DVR model. This reference simulation of the intermediate version is also compared with trends from other studies.

At the end of this section a comparison is also made with the newest version of the DVR model, which became available at the end of this research. Therefore, it could not be used in this research, but it can be checked if it is deemed more reliable than the intermediate version of the DVR model.

Comparing the intermediate version of the DVR model to the old version and other studies

The intermediate version of the DVR model is regarded as an improvement upon the old version of the DVR model, as many changes have been made (Section 3.4) in order to make the DVR model more capable of reproducing long term observations in the discharge distribution at the Pannerdensch Kop and of reproducing the morphological trends in the Dutch Rhine branches.

Figure 5.1 shows the domain averaged bed change of the domains the Boven-Waal, Midden-Waal,

Beneden-Waal and Pannerdensch Kanaal, both for the reference run of this research and for the reference run of Pfeijffer (2023). In the old version of the DVR model used by Pfeijffer (2023), it was known that the bed degradation in the Midden-Waal was severely overestimated (-2 cm/year). In the intermediate version, the bed degradation in the Midden-Waal is reduced to -1.2 cm/year. This is still approximately twice as much bed degradation in the Midden-Waal than expected based on the trends in Table 1.1. However, it is known that an erosion wave originating from the initial reaction to the fixed layer at Nijmegen causes additional erosion in the Midden-Waal (Appendix C) in the intermediate version.

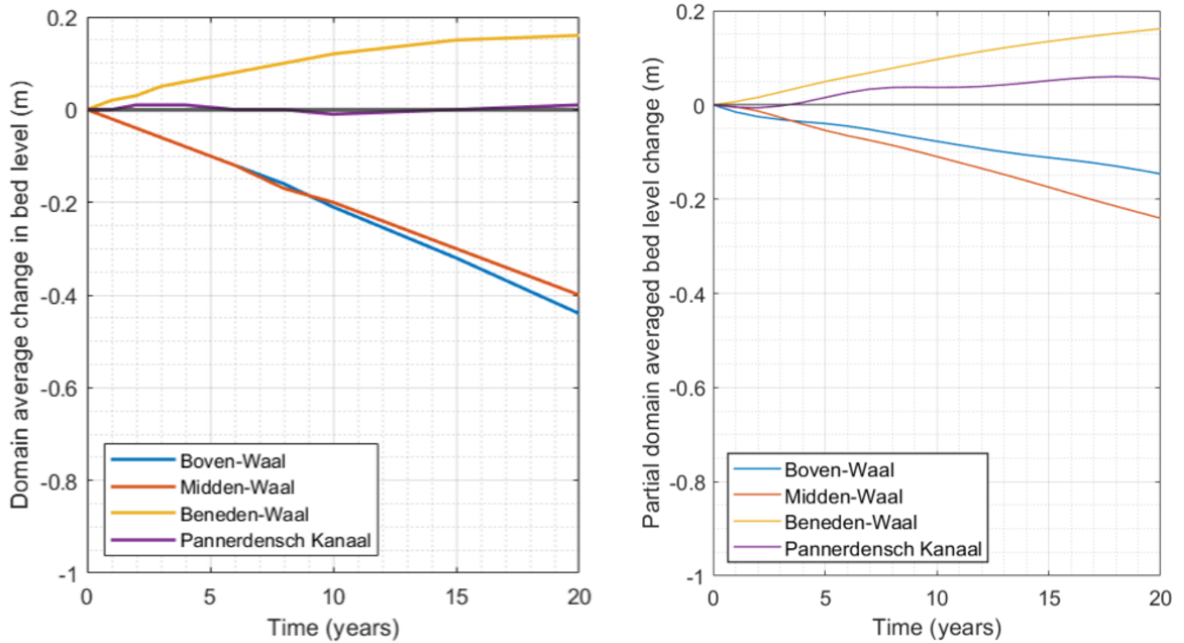

FIGURE 5.1: Comparison between the domain averaged bed level change of the reference run of Pfeijffer (2023) on the left side and Sim_{REF} of this research on the right side.

When looking at the trends of other studies (Table 1.1), it can also be noticed that the old DVR model has approximately 50% more bed degradation in the Boven-Waal, whereas the intermediate version has approximately 50% less bed degradation in the Boven-Waal. Differences are also found in the bed level change of the Pannerdensch Kanaal. The trends in Table 1.1 indicate bed degradation of about -1.2 cm/year in Pannerdensch Kanaal, whereas the net sedimentation/erosion rate remained approximately 0 throughout the simulation of Pfeijffer (2023) with the old version of the DVR-model. The intermediate version of the DVR even experiences sedimentation in the Pannerdensch Kanaal over 20 years (+0.3 cm/year). The Beneden-Waal seems to behave similar in both the old and intermediate version of the DVR model and the trends in Table 1.1. It is expected to experience slight sedimentation in the coming years.

The cause for the differences between the mentioned sources is identifiable. The old version of the DVR model used by Pfeijffer (2023) imposed a bed degradation of -1.5 cm/year at the upstream boundary. This imposed bed degradation was removed from in the intermediate version of the DVR model, which explains why there is less bed degradation in the intermediate version for the Pannerdensch Kanaal, Boven-Waal and Midden-Waal. When looking at the relative difference in bed level change in the Boven-Waal and Pannerdensch Kanaal, it can be noticed that the reference simulation of the old version of the DVR model has a relative difference of 45 centimeter between the two branches after 20 years, while this difference is only 20 centimeter after 20 years in the reference run of the intermediate version. This change in difference between the

Boven-Waal and Pannerdensch Kanaal in the old version is mainly caused by the excessive erosion in the Boven-Waal. Therefore, it is expected that the discharge distribution at the Pannerdensche Kop is behaving better in the intermediate version of the DVR model.

The discrepancy between the trends in Table 1.1 and the output of the intermediate model are explained by the fact that the Boven-Rijn is not expected to erode in the trends of Table 1.1, whereas the Boven-Rijn does experience an erosion of about -0.17 cm/year in the intermediate version. This causes more sediment to end up in the Boven-Waal and Pannerdensch Kanaal, which in turn explains why there is more sedimentation in the Boven-Waal and Pannerdensch Kanaal in the intermediate version, compared to the trends in Table 1.1. The trends in Table 1.1 are based on measured bed level data and capture either the trends of the past or they are an extrapolation of observed long-term trends. Therefore, such prognoses do not account for possible changes in these trends in the future.

To conclude, there are substantial differences in the reference simulation of the old and intermediate version of the DVR model. However, they can be readily explained. The same is true for the differences between the morphological trends of other studies in Table 1.1 and the output of the intermediate version of the DVR model. There are no reasons to believe that the old version or the trends of the other morphological studies (Table 1.1) are more reliable than the used intermediate version of the DVR model. Based on the improvements that have been made to get the model output of the intermediate version closer to what is happening in the Dutch Rhine branches in reality (Section 3.4), the output of the intermediate version is likely to be as trustworthy, if not more trustworthy, than the other sources.

Comparing the intermediate and new version of the DVR model

During the course of this research, the new version of the DVR model has actually been released and the initial reaction to the fixed layers has been improved. Figure 5.2 shows that in the newer version of the DVR model, the bed levels are vastly different, especially around the fixed layers. Differences are big and even in the order of meter.

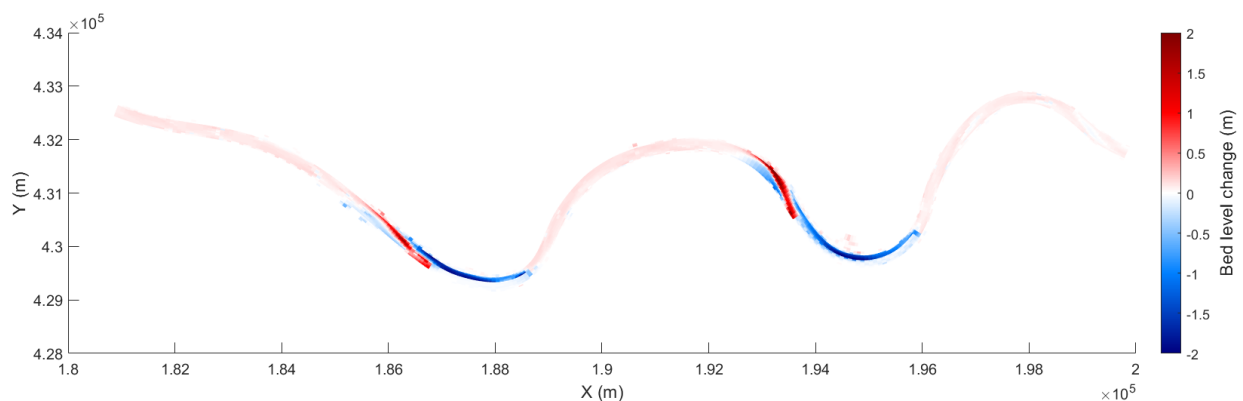

FIGURE 5.2: Comparison between the bed levels after 20 years for the reference simulation in the intermediate and newer version of the DVR model. Positive values indicate a higher bed level after 20 years in the reference run of the newer version of the DVR model. Negative values indicate a lower bed level after 20 years in the reference run of the newer version of the DVR model

Initially, in the intermediate version, unrealistic bed levels would be present around fixed layers, which also had a large influence on the bed levels downstream. The roughness values around the fixed layers were changed and a different method of morphological spin-up was used in the new version. This method of morphological spin-up first requires local morphological spin-up around the fixed layers, followed by the same morphological spin-up of the whole model domain as performed in this research. From Figure 5.2 it can be seen that the unrealistic sedimentation in the inner bend at the fixed layers is countered. Similarly, the increased erosion directly downstream of the fixed layers, which was caused by a reaction to initial sedimentation on the fixed layers, is greatly reduced. The erosion wave that propagated downstream due to the initial reaction to the fixed layers has also been reduced, which is visible in both Figure 5.2 and 5.3. Apart from the different bed levels around fixed layers, the sedimentation and erosion patterns in the rest of the Boven-Waal that were visible in Figure 4.6 are thus the same, with only a slightly higher bed in the reference simulation of the newer version of the DVR model (Figure 5.2).

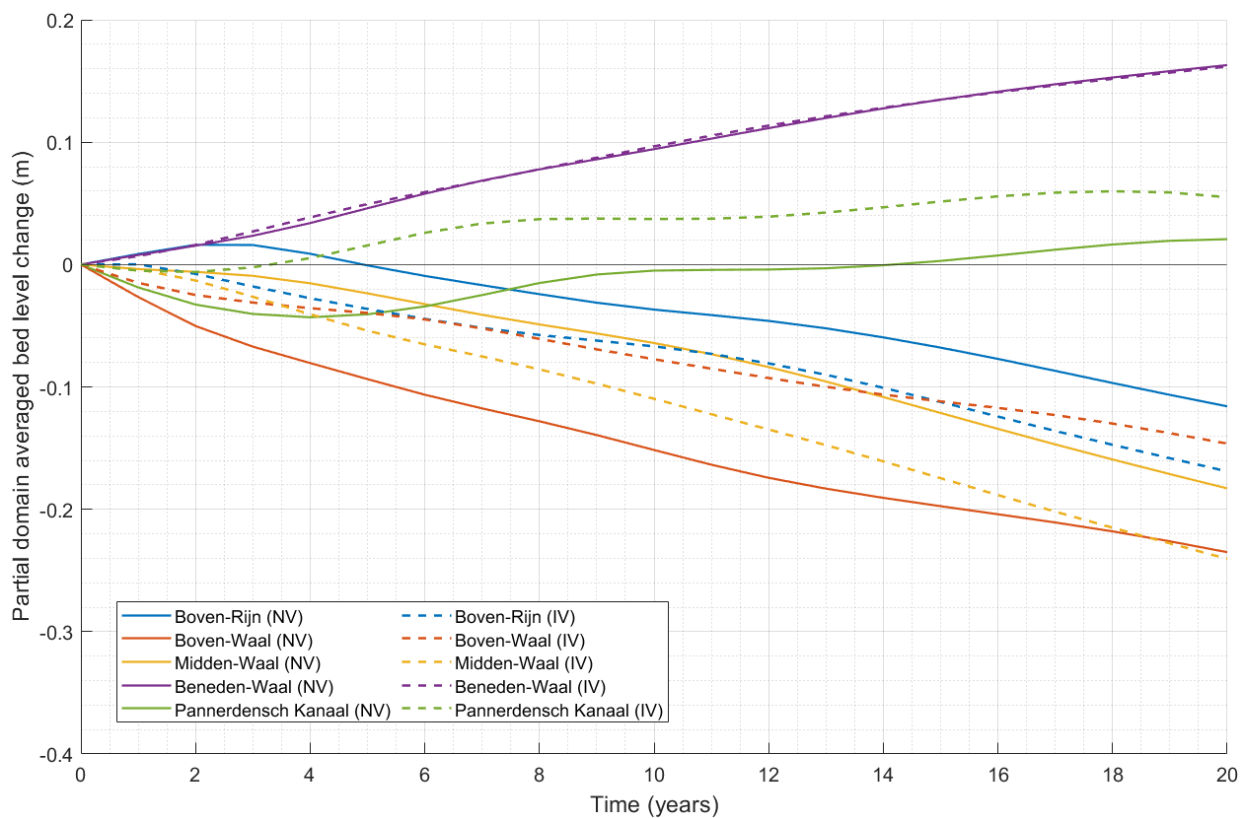

FIGURE 5.3: Comparison between the domain averaged bed level change of the used intermediate version of the DVR model and the latest version of the DVR model. The solid lines indicate the domain averages of the newer version (NV) and the dashed lines indicate the domain averages of the intermediate version (IV).

Figure 5.3 shows the domain averages in the reference simulation of the intermediate and new version of the DVR model. The Boven-Waal experiences more bed degradation in the new version, while the erosive wave through the Midden-Waal is reduced. The Boven-Rijn is experiencing sedimentation in the first five years, after which it will start to erode. Similarly, the Pannerdensch Kanaal will remain to erode in the first five years, but will stabilise afterwards and even shows sedimentation in the last five years. This is a logical response to the Boven-Rijn that starts eroding after year five. Due to this erosion of the Boven-Rijn, the bed degradation in the Boven-Waal also seems to stabilise towards the end of the simulation. Figure 5.3 actually shows that averaging bed

level change over 20 years seems to be a too long period, as some branches experience a change in trend during way smaller periods within the 20 years of simulation. Still, to enable comparison, Table 5.1 shows the domain averaged bed level change over 20 years of morphological simulation with the intermediate (IV) and new (NV) version of the DVR model. The values of the domain averaged bed level change in the reference simulation of the new version are actually closer to the trends presented in 1.1. However, as previously mentioned, deviations compared to these trends do not have to be unrealistic, as these trends make use of measured bed level data of the past. What is more important is that the trends in Figure 5.3 actually correspond to recent observations (Sloff et al., 2023a). Recent observations actually show that the bed degradation in some river branches (e.g. Pannerdensch Kanaal and Midden-Waal) is stabilizing or even reversing to sedimentation (Sloff et al., 2023a). These recent observations have been taken into account by the makers of the DVR model during the acceptance of the model output (Sloff et al., 2023a).

TABLE 5.1: Domain averaged bed level change in cm/year for the intermediate and new version of the DVR model.

River branch	IV	NV
Boven-Rijn	-0.85	-0.58
Pannerdensch Kanaal	+0.27	+0.10
Boven-Waal	-0.73	-1.18
Midden-Waal	-1.20	-0.91
Beneden-Waal	+0.81	+0.81

To conclude, the new version of the DVR model seems more reliable than the intermediate version, as it is able to eliminate the initial reaction to the fixed layers in the model domain. Implications for this research remain limited to the results in the Boven-Waal likely being an underestimation of the bed degradation. The Boven-Rijn still erodes in the new version, although only after experiencing 5 more years of sedimentation, followed by less erosion than simulated by the intermediate version of the DVR model in the last 15 years of simulation. This leads to less sediment availability in the Boven-Waal in the new version of the DVR model, compared to the intermediate version.

6 | Conclusion & Recommendations

This chapter will present the conclusions that can be drawn from this research. Followed by recommendations for further research into the mitigation of bed degradation in the Dutch Rhine branches.

6.1 Conclusion

The aim of this research was to gain insight into the cumulative effects of river interventions in the Boven-Waal, when they are combined to mitigate the ongoing bed degradation and its consequences in the Dutch Rhine delta. This was done by schematising five simulations that combined different river interventions in the Boven-Waal with the two dimensional DVR model, which is currently the best tool for performing long-term morphological simulations in the Dutch Rhine delta. A morphological spin-up was performed to reduce initial reactions of the model to the input data. This spun up bed was then used as a starting point for each of the five simulations. Each simulation comprised 20 years of morphological simulation. In this section, an answer is formulated to the main research question:

'How can different combinations of river interventions in the Boven-Waal help the mitigation of ongoing long-term bed degradation and its consequences in the Dutch Rhine delta?'

Different combinations of river interventions in the Boven-Waal are able to influence the ongoing long-term bed degradation and its consequences in the Dutch Rhine delta. The ongoing bed degradation in the reference simulation does not appear to stabilize after 20 years of morphological simulation. Conversely, all other performed simulations appear to exhibit stabilizing trends towards the end of the simulation. This suggests that every combination of river interventions studied, at least contributes to the stabilization of the erosion trend after 20 years.

The Boven-Waal seems to function as a scale. Different combinations of river interventions can only mitigate the ongoing long-term bed degradation and its consequences when they are appropriately applied. As if interventions induce too much sedimentation in the upstream section of the Boven-Waal, the consequences will be visible by large erosion in the downstream section of the Boven-Waal.

Both, the side channels that activate at OLA and the LTDs in this research, seem to induce too much sedimentation. To let combinations of river interventions help mitigating ongoing long-term bed degradation and its consequences, the most upstream river interventions have to generate less sedimentation in the main channel, such that more sedimentation will also likely be caused downstream in the Boven-Waal. So, it is suggested that both side channels and LTDs in this research activate for higher discharges, such that the sedimentation in the main channel is less extreme. The side channels in this research should ideally be activated for medium discharges (1543 - 1945 m³/s), while the LTDs should thus not be activated for a discharge of 1543 m³/s, but rather at higher discharges. This should be combined with gradually increasing the dimensions of the river interventions, the further they are located downstream. Continuously less sediment will be present in the flow as it moves downstream, as more sediment compared to the reference situation is already captured upstream. Even lower flow velocities are required downstream to induce the same amount of sedimentation. This gradual increase in dimensions is only applicable for groynes

lowering and LTDs, as there is simply no room for side channels (as implemented in this research) in the downstream section of the Boven-Waal, which would always result in additional erosion here.

When solely implementing river interventions in the Boven-Waal, there seems to be no justification for pursuing mitigation of bed degradation via the (re)construction of side channels and summer dike lowering. Due to their induced local effects on the main channel, the gradient between the upstream and downstream section of the Boven-Waal is increased, hereby increasing erosion when averaging over the whole Boven-Waal. Groyne lowering always seems to have a small positive effect for the mitigation of bed degradation in the main channel. This effect is in the order of 4-5 centimeter after 20 years, averaged over the Boven-Waal. LTDs induce sedimentation in the main channel after approximately 4 years after their implementation. This research indicates that optimization efforts for combining river interventions are better focused on groyne lowering, LTDs and possible other river interventions that have not been addressed in this research.

This research showed that the most effective combination of river interventions for mitigating bed degradation and its impacts, is to implement groyne lowering to the minimum permissible height of +1.20 meter OLR combined with the deployment of Longitudinal Training Dams (LTDs), as outlined in 'Globaal Ontwerp Langsdammen' (Huthoff et al., 2015), throughout the entire Boven-Waal. This simulation reduced overall bed degradation the most in the Boven-Waal (+0.6 cm/year). Though when looking at the output of the reference simulation of the new version of the DVR model, it has to be noted that the bed degradation in the Boven-Waal is likely underestimated in the used intermediate version of the DVR model. Moreover, the combination of groyne lowering and LTDs is closest to complying with the desired discharge distribution in IRM (Programma Integraal Riviermanagement, 2023). This combination of groyne lowering and LTDs is also able to induce reduction in high water levels over the longest distance in the Boven-Waal, with a relatively small downstream peak. The only downside of *Sim_{GL-LTD}* being that it leads to insufficient navigation depth at the fixed layer at Nijmegen, but this is true for all schematised simulations in this research.

6.1.1 Practical relevance for the future development of the Dutch Rhine branches

This research shows that a clear plan has to be made about how the Dutch Rhine branches should function in the future. For example, redirecting more discharge to the Pannerdensch Kanaal may be beneficial for preventing droughts in the north and replenishment of our fresh water storage (the IJsselmeer), but it contradicts the goal of having sufficient water depth in the most important navigation channel in the Dutch Rhine delta, the (Boven-)Waal, which is visible from the insufficient water depths during OLA at the end of the simulations of this research. Besides, redirecting more discharge towards the Pannerdensch Kanaal also worsens the salinization of the west of the Netherlands.

This again shows that IRM is about finding an optimal balance between the different goals that are present in the Dutch Rhine delta. At least it becomes clear from the results that the discharge distribution at low discharges should not shift more towards the Pannerdensch Kanaal, if the implemented river interventions fail to increase the bed level around the fixed layer at Nijmegen sufficiently. So restoring the discharge distribution is not a goal that can be pursued on its own. Additionally, if the discharge distribution at the Pannerdensch Kop shifts more towards the Pannerdensch Kanaal by implementing river interventions in the Boven-Waal, it seems inevitable that more discharge will flow to the Boven-Waal during high discharges. At least if LTDs are used to achieve this goal, which seems like the most promising river interventions for achieving this goal based on this study. This is not necessarily a problem, but it requires large scale widening of the winter bed of the Waal, as during extreme high discharges, the Waal is currently too tight for this shift in discharge distribution at the Pannerdensch Kop (Klijn et al, 2022).

6.2 Recommendations

Based on the findings of this research, recommendations are made regarding validation of the DVR model and the optimisation of combining of river interventions.

6.2.1 Validating DVR model

The DVR model is currently the best suited tool for performing long-term morphological simulations in the Dutch Rhine branches. However, it does not take away from the fact that many improvements can still be made upon the model. For starters, it would be highly interesting to dedicate research to the validation of the reference simulation with recent measurements. The bed composition of the DVR model is based on measurements dating from 2020. So measurements of the past 3 years and measurements that will be performed in the future can validate if the DVR model is actually simulating what is happening in reality. Of course, this comparison cannot be performed one on one, as depending on the length of the morphological spin-up, it will also include a part of the ongoing bed degradation. Besides, the hydrograph at the upstream boundary should correspond to the discharges that occurred during the same period of which the bed level measurements originate. Still, such validation can confirm if the trends in the different river branches are true to reality. Perhaps even more interesting, measurements in the coming few years could confirm if the switch in trends that are visible in the Boven-Rijn and Pannerdensch Kanaal in the DVR model are also happening. Research that validates the outcomes of the DVR model would greatly increase the confidence that researchers and policy makers can have in the results of their schematizations within the DVR model. This research should logically be done with the new version of the DVR model and not the intermediate version that was used in this research, as instabilities around fixed layers are largely fixed in the newest version.

It would also be interesting to perform the same simulations as in this research with the newest version of the model. This will likely provide a better insight into the effects of the different river interventions in the Boven-Waal, as in the intermediate version the erosion in the Boven-Waal is underestimated. To make such research even more interesting for IRM, an upstream hydrograph could be used that accounts for climate change throughout the morphological simulation. Moreover, simulations could be performed for a longer duration, such that the results of the different schematizations are closer to the morphological equilibrium.

6.2.2 Optimising river interventions

From the results of this research it becomes clear that combinations of river interventions can help mitigating bed degradation. However, the design parameters of these river interventions are clearly not optimal in this research. Future research could improve upon this. For example, first the induced effects of single river interventions could be addressed, such that the design parameters of an added river intervention can be adapted to these induced effects of the other river intervention. However, this fine tuning of design parameters is impossible for many parameters (e.g. riparian/side channel width), due to the coarse grid size of the DVR model. So if research in optimization of river intervention dimensions is performed, the grid of the DVR model should be refined. Grid refinement would also enable investigation of other promising river interventions in countering bed degradation, such as groyne extension or restoration of old meanders. However, this would increase computational times, which is always an important trade-off.

It would become even more interesting when the implementation of combinations of river interventions are phased in time in the morphological simulation. In reality, it logically takes time to build the river interventions and depending on when each river intervention is build, the effects on hydraulics and morphology can be vastly different. When first building a single river intervention, it also becomes more clear what the actual effect on hydraulics is in reality, which in turn makes it easier to determine the dimensions of the next intervention that is to be added. Such research in which phasing of river interventions is performed could also further investigate other combinations of river interventions, Of which sediment nourishments are likely the most interesting river intervention, as it seems likely that adaptive sediment management is necessary to stabilize the bed (Sloff et al., 2023b). Especially during construction of river interventions and the first few years after construction, as initial reactions of the bed to the river interventions are expected to be large. Performing research in which phasing in time is included seems like a logical next step in morphological research, which will greatly help translating model results to actual implementation in reality.

Bibliography

AHN. Retrieved May 24, 2024, from <https://www.ahn.nl/ahn-viewer>.

Arkesteijn, L., Blom, A., Czapiga, M., Chavarrías, V., and Labour, R. (2019). The Quasi-Equilibrium Longitudinal Profile in Backwater Reaches of the Engineered Alluvial River: A Space-Marching Method. *Journal of Geophysical Research: Earth Surface*, 124(11):2542–2560.

Baar, A., Weisscher, A., and Kleinhans, M. (2020). Interaction between lateral sorting in river bends and vertical sorting in dunes. *Sedimentology*, 67:606–626.

Barneveld, H., Reneerkens, M., van Vuren, S., Blom, A., and Paarlberg, A. (2022). Hoe stoppen we bodemerodatie op de Rijn?: Rivierbodems zakken al sinds twee eeuwen. *Bodem*, 4:28–30.

Becker, A. (2021). Slim suppleren Boven-Waal. *Report: Deltares*.

Beekers, B., Van den Bergh, M., Braakhekke, W., Haanraads, K., Litjens, G., Van Loenen Martinet, R., Van de Mark, C., Otterman, E., Pluimers, J., Rademakers, J., Reeze, B., Sterk, M., Teunissen, T., Willems, D., and Van Winden, A. (2018). Ruimte voor Levende Rivieren. *Report: WWF*.

Blom, A. (2016). Bed degradation in the Rhine River. *Delft University of Technology*.

Bom, S. and van Leeuwen, B. (2020). Rivierkundig Onderzoek Krib- en Oeververlaging Pannerdensch Kanaal. *Report: Svasek*.

Buitink, J., Tsiokanos, A., Geertsema, T., ten Velden, C., Bouaziz, L., and Sperna Weiland, F. (2023). Implications of the KNMI'23 climate scenarios for the discharge of the Rhine and Meuse. *Report: Deltares*.

Chowdhury, M., Blom, A., Ylla Arbós, C., Verbeek, M., Schropp, M., and Schielen, R. (2023). Semicentennial Response of a Bifurcation Region in an Engineered River to Peak Flows and Human Interventions. *Water Resources Research*, 59.

Clayton, J. (2010). Local sorting, bend curvature, and particle mobility in meandering gravel bed rivers. *Water Resources Research*, 46.

Collas, F., Buijse, A., van den Heuvel, L., van Kessel, N., Schoor, M., Eerden, H., and Leuven, R. (2018). Longitudinal training dams mitigate effects of shipping on environmental conditions and fish density in the littoral zones of the river Rhine. *Science of the Total Environment*, 619–620:1183–1193.

Czapiga, M., Blom, A., and Viparelli, E. (2022). Efficacy of Longitudinal Training Walls to Mitigate Riverbed Erosion. *Water Resources Research*.

de Ruijscher, T., Hoitink, A., Naqsband, S., and Paarlberg, A. (2019). Bed morphodynamics at the intake of a side channel controlled by sill geometry. *Advances in Water Resources*, 134.

de Vriend, H. (2015). The long-term response of rivers to engineering works and climate change. *Proceedings of the Institution of Civil Engineers*, 168(CE3):139–144.

Eerden, H. (2022). WaalSamen: Pilot Langsdammen. *Report: Rijkswaterstaat*.

- Flores, N., Collas, F., and Leuven, R. (2022). Geomorphological development of aquatic mesohabitats inshore channels along longitudinal training dams. *Remote Sensing in Ecology and Conservation*, 8(5):744–760.
- Frings, R., Hillebrand, G., Gehres, N., Banhold, K., Schrievers, S., and Hoffmann, T. (2019). From source to mouth: Basin-scale morphodynamics of the Rhine River. *Earth-Science Reviews*, 196.
- Geerling, G. and van Kouwen, L. (2011). Handvatten voor Nevengeulen in de Rijnakken. *Report: Deltares*.
- Huthoff, F., Paarlberg, A., Vieira da Silva, J., and de Jong A.K. (2015). Globaal ontwerp langsdammen: Rijnspltsingspuntegebied en overige Rijnakken. *Report: HKV*.
- Huthoff, F., van Vuren, S., Barneveld, H., and Scheel, F. (2010). On the importance of discharge variability in the morphodynamic modeling of rivers. *Proceedings of the Fifth International Conference on Fluvial hydraulics*.
- Klijn, F., Leushuis, H., Treurniet, M., van Heusden, W., and van Vuren, S. (2022). Stroom- en afvoerbeschouwing Rijn en Maas ten behoeve van ontwerp en besluitvorming: Programma Integraal Riviermanagement. *Report: Ministerie van Infrastructuur en Water, Den Haag*.
- Krabbendam, J. and van Putten, D. (2024). Afvoerverdeling 2024. *Rijkswaterstaat*.
- Liptai, E. (2023). Supply-driven nourishment strategies for mitigating bed degradation in the Waal. *University of Twente*.
- Meyer-Peter, E. and Müller, R. (1948). Formulas for Bed-Load Transport. *In proceedings of the 2nd meeting of the international association for hydraulic research, Stockholm*, pages 39–64.
- Ministerie van Infrastructuur en Waterstaat (2023). Naar een toekomstbestendig rivierengebied: Ontwerp Programma Integraal Riviermanagement. *Report: IenW, LNV, BZK and RWS*.
- Mosselman, E. (2022). The Dutch Rhine branches in the Anthropocene – Importance of events and seizing of opportunities. *Geomorphology*, 410.
- Oldenhof, M. (2021). The morphological modelling of river interventions. *University of Twente. University of Twente*.
- Ottevanger, W., Giri, S., and Sloff, K. (2015). Sustainable Fairway Rhinedelta II: Effects of yearly bed stabilisation nourishments, Delta Program measures and training walls. *Report: Deltares*.
- Ouwkerk, S., Huthoff, F., Zuidewijk, M., and de Wit, L. (2023). Stroom- en afvoermaatregelen IRM Rijn en Maas. *Report: HKV and Witteveen + Bos*.
- Paarlberg, A. and Schippers, M. (2020). Inverse modellering evenwichtseffect maatregelen op zomerbedbodem: afleiden dimensies van maatregelen. *Report: HKV*.
- Paarlberg, A. and Van Lente, J. (2021). Testen 1D morfologisch model Rijnakken: Testcasus plan Ruimte voor Levende rivieren. *Report: HKV Lijn in Water*.
- Parker, G., Klingeman, P., and McLean, D. (1982). Bedload and size distribution in paved gravel-bed streams. *Journal of the Hydraulics Division*, 108(4):544–571.
- Pfeijffer, C. (2023). The effects of different designs of longitudinal training dams on countering bed degradation for different discharge scenarios in the River Waal. *University of Twente*.
- Programma Integraal Riviermanagement (2023). Naar een toekomstbestendig rivierengebied Ontwerp Programma onder de Omgevingswet (POW) Integraal Riviermanagement. *Report: Programma Integraal Riviermanagement*.

- Rijkswaterstaat WVL (2019). Rivierkundig Beoordelingskader voor ingrepen in de Grote Rivieren. *Report: Rijkswaterstaat WVL*.
- Rorink, T. (2022). The potential of side channels to mitigate large scale bed degradation in the Dutch rhine distributaries : A 1D modelling study. *University of Twente*.
- Rura-Arnhem (2022). Betrekkingslijnen Rijntakken. *Report: Rura-Arnhem*.
- Sieben, A. (2010). Methodiek inschatting morfologische effecten in het zomerbed door lokale rivieringrepen. *Report: Rijkswaterstaat*.
- Sloff, C., Van der Sligte, R., and Ottevanger, W. (2013). Riviermorfologisch Deltamodel: testen RMD. *Report: Deltares*.
- Sloff, K. (2011). DVR toolbox for sediment management in the Rhine delta. *Report: Deltares*.
- Sloff, K. (2019). Prognose bodemligging Rijntakken 2020-2050. *Report: Deltares*.
- Sloff, K. (2022). Ruimtelijke en temporele interpretatie van bemonstering bodemsamenstelling Rijntakken. *Report: Deltares*.
- Sloff, K., Becker, A., Paarlberg, A., and van Denderen, P. (2023a). 2D morfologisch model IRM. *Report: Deltares*.
- Sloff, K., Paarlberg, A., van Denderen, P., Barneveld, H., and Mosselman, E. (2023b). Onderbouwing beleidskeuze bodemligging IRM. *Report: HKV and Deltares*.
- Sloff, K., van der Sligte, R., and Ottevanger, W. (2014). Morfologische Pakketsom Waal: Morfologische effecten Ruimte-voor-de-Riviermaatregelen. *Report: Deltares*.
- ten Brinke, W. (2019). Effecten morfologische ontwikkelingen op functies Rijn en Maas. *Report: Blueland Consultancy BV*.
- van Denderen, P., Schielen, R., Straatsma, M., Kleinhans, M., and Hulscher, S. (2019a). A characterization of side channel development. *River Research and Applications*, 35(9).
- van Denderen, R., Kater, E., Jans, L., and Schielen, R. (2022). Disentangling changes in the river bed profile: The morphological impact of river interventions in a managed river. *Geomorphology*, 408.
- van Denderen, R., Schielen, R., Westerhof, S., Quartel, S., and Hulscher, S. (2019b). Explaining artificial side channel dynamics using data analysis and model calculations. *Geomorphology*, 327:93–110.
- van Putten, D. (2023). Methodiek vereffenen afvoerverdeling. *Report: Rijkswaterstaat Oost Nederland*.
- van Putten, D. and Vrijaldenhoven, B. (2022). Bepaling Overeengekomen Lage Rivierwaterstand 2022 voor de Nederlandse Rijntakken. *Report: Rijkswaterstaat Oost Nederland*.
- van Vuren, S., Paarlberg, A., and Havinga, H. (2015). The aftermath of “Room for the River” and restoration works: Coping with excessive maintenance dredging. *Journal of Hydro-environment Research*, 9:172–186.
- Waterdiepte kaarten Rijntakken. Retrieved December 15, 2024, from <https://maps.rijkswaterstaat.nl/gwproj55>.
- Welsch, N. (2021). Two-dimensional morphological modelling of the effects of the room for living rivers vision in the Middle-Waal. *University of Twente*.

Ylla Arbós, C., Blom, A., Schielen, R., van Vuren, S., and Snoek, Y. (2024). How can floodplain lowering and sediment nourishments help mitigate channel bed incision? *Report: Delft University of Technology and Rijkswaterstaat*.

Ylla Arbós, C., Blom, A., van Vuren, S., and Schilene, R. (2019). Bed level change in the upper Rhine Delta since 1926 and rough extrapolation to 2050. *Delft University*.

Ylla Arbós, C., Blom, A., Viparelli, E., Reneerkens, M., Frings, R., and Schielen, R. (2021). River Response to Anthropogenic Modification: Channel Steepening and Gravel Front Fading in an Incising River. *Geophysical Research Letters*, 48(4).

Yossef, M. and de Vriend, H. (2010). Flow Details near River Groynes: Experimental Investigation. *Journal of Hydraulic Engineering*, 137:504–516.

Yossef, M., Jagers, H., van Vuren, S., and Sieben, A. (2008). Innovative techniques in modelling large-scale river morphology. *Report: Deltares and Rijkswaterstaat*.

A | Downstream boundary conditions

Tables A.1, A.2 and A.3 show the downstream boundary conditions of the Beneden-Waal, Nederrijn and IJssel respectively. It can be seen that the downstream boundary conditions of the Beneden-Waal and IJssel are complete Q/h relationships. This is only partially true for the downstream boundary condition of the Nederrijn. Here, a Q/h relationship is only used for the higher discharges at Lobith. This was done by the creators of the DVR model, as the downstream boundary condition is located just past the weir at Driel. Therefore, instead of a Q/h relationship, a discharge withdrawal was imposed for these lower discharges. The amount of discharge withdrawal imposed is based on the 'vereffende afvoerverdeling 2023' of Rijkswaterstaat (van Putten, 2023).

TABLE A.1: Downstream boundary condition of the Beneden-Waal (wl2c).

Discharge at Lobith (m^3/s)	Water level at end of the Beneden-Waal (m+ NAP)
1020	0.49
1294	0.59
1543	0.68
1954	0.81
2601	0.99
3384	1.29
4353	1.65
5506	2.13
7009	2.79

TABLE A.2: Downstream boundary condition of the Nederrijn (nr1a).

Discharge at Lobith (m^3/s)	Water level at end of the Nederrijn (m+ NAP)
1020	N/a
1294	N/a
1543	N/a
1954	N/a
2601	N/a
3384	7.60
4353	8.40
5506	9.29
7009	10.20

TABLE A.3: Downstream boundary condition of IJssel (yac3).

Discharge at Lobith (m^3/s)	Water level at end of the IJssel (m+ NAP)
1020	-0.26
1294	-0.23
1543	-0.21
1954	-0.17
2601	-0.12
3384	-0.06
4353	0.02
5506	0.11
7009	0.22

B | Checking for convergence

For every performed simulation, the calculations of the model have been checked for convergence at the bifurcation point, the Pannerdensch Kop. In other words, the model should have found a steady hydrodynamic situation within the chosen hydrodynamic spin-up period. If this is not the case, this would imply that a longer hydrodynamic spin-up period is needed, which translates into longer computational times. In order to check this convergence, several characteristics of the system have been checked. These characteristics being water levels, flow velocities and momentary discharges through cross-sections. The latter characteristic being directly related to the water level and flow velocity. So if the momentary discharge has converged, the system can be assumed to have found a steady hydrodynamic situation. Figure B.2 shows these momentary discharges in the Boven-Waal and Pannerdensch Kanaal for Sim_{SC-GL-LTD}. They have been measured through the cross-sections at river kilometre 868 of both river branches. These cross-sections are visualized in figure B.1.

Looking closely at Figure B.2, it can be seen that the momentary discharges through the cross-sections already seem to be steady after about 50 minutes of hydrodynamic simulation. Therefore, based on Figure B.2, the used hydrodynamic spin-up period of 540 minutes seems to be more than enough. This is true for the low and medium discharges. However, closer inspection reveals that for the highest upstream discharge (7009 m³/S), the full hydrodynamic spin-up period of 540 minutes is necessary (Figure B.3). Performing this analysis for every simulation ensures that morphological development happens during a steady hydrodynamic situation. If this is not done and the model is still unsteady when the morphological calculations start, unrealistic morphological development will occur, which decreases the credibility of the output.

Logically, the more river interventions are included in a simulation, the more bed level changes will occur. This would translate in a need for longer hydrodynamic spin-up times. However, prior to every simulation the model is spun-up hydrodynamically for two days per steady discharge step prior to the simulation. This ensures that the DVR model has a steady flow field for each steady discharge step. These flow fields are then imposed on the model at the start of the actual simulation. This ensures that during the actual simulation, a shorter hydrodynamical spin-up period can be used, as the momentary discharges will converge earlier due to the imposed flow fields.

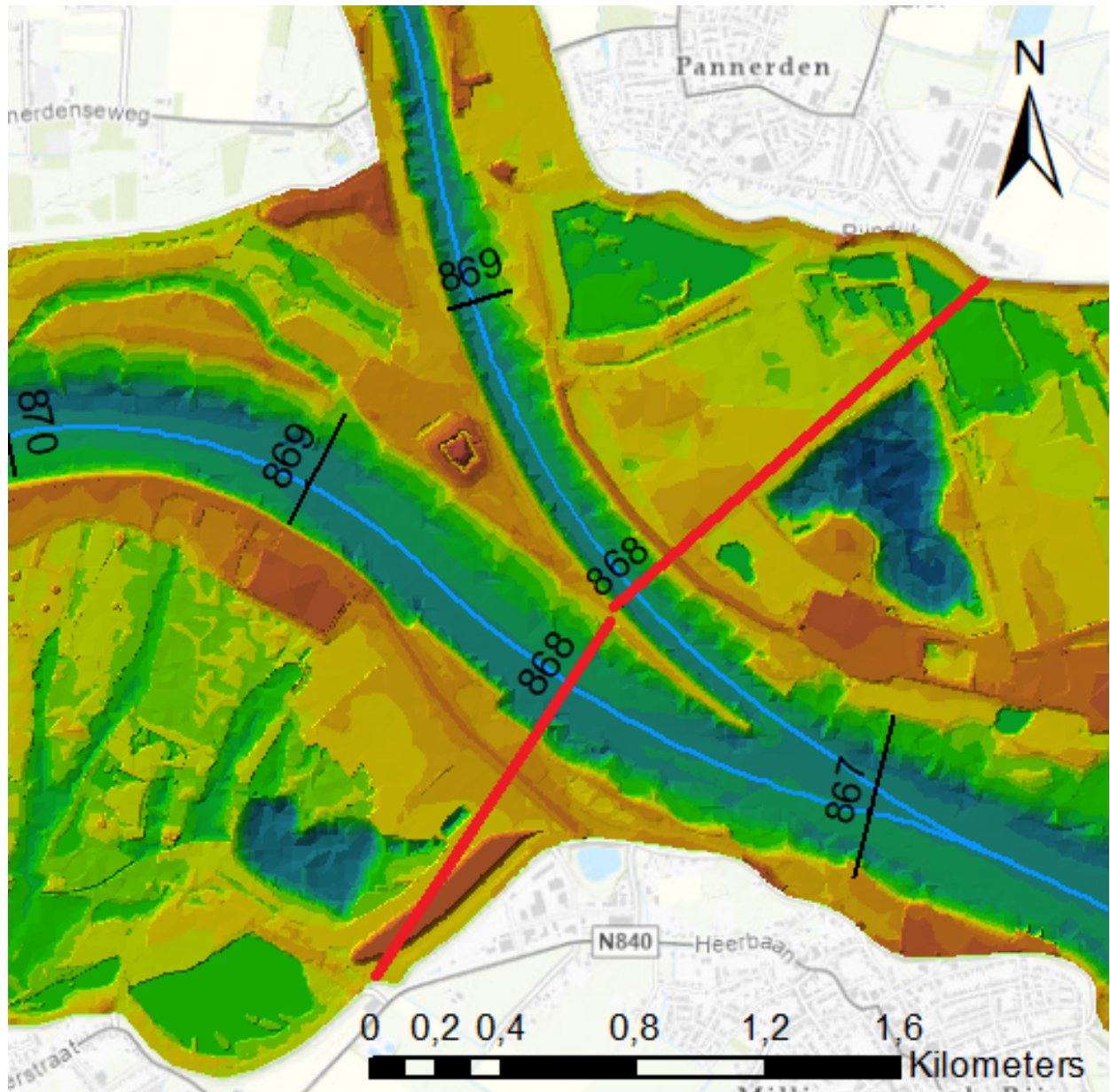

FIGURE B.1: Map showing the Pannerdensche Kop and the cross-sections in the Boven-Waal and Pannerdensch Kanaal used in Figure B.2.

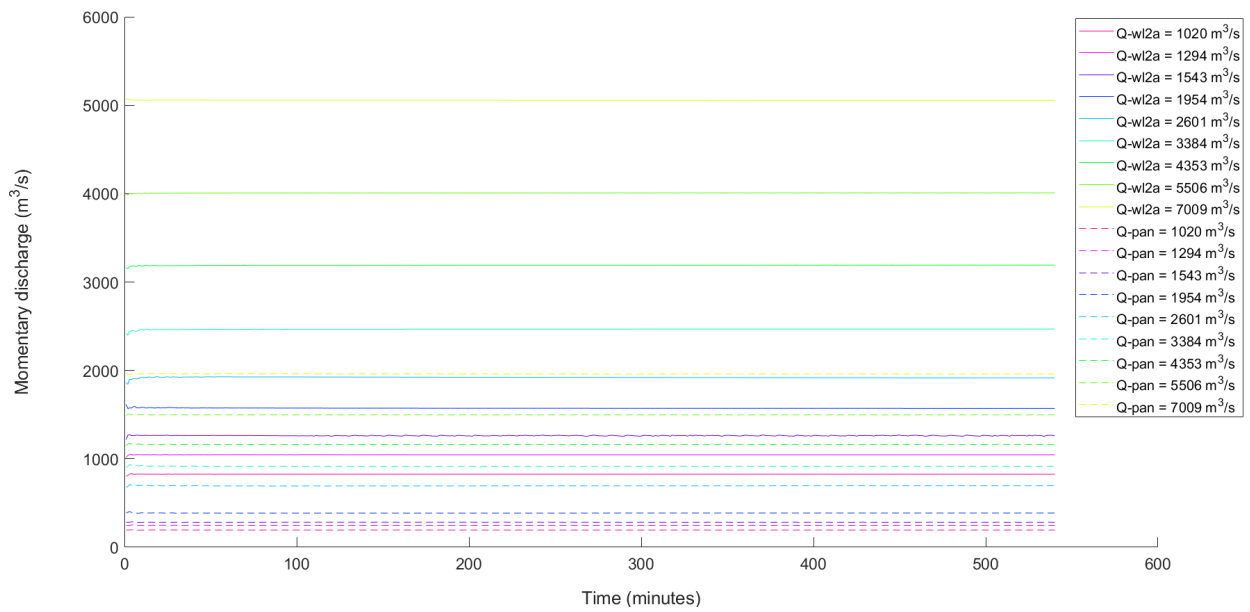

FIGURE B.2: Momentary discharges through the cross-sections at river kilometre 868 of the Boven-Waal and Pannerdensch Kanaal for the different upstream discharges of the DVR model in $\text{Sim}_{SC-GL-LTD}$

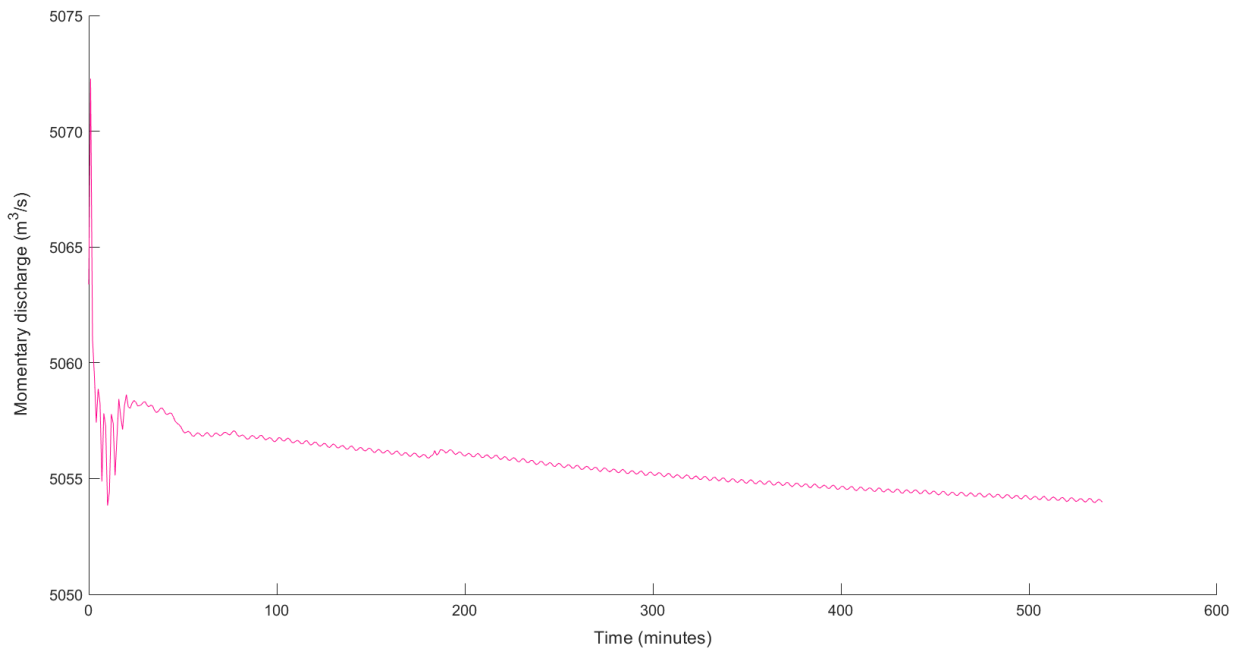

FIGURE B.3: Momentary discharge through the cross-section at river kilometre 868 of the Boven-Waal for an upstream discharge of 7009 m^3/s in $\text{Sim}_{SC-GL-LTD}$

C | Assessment of the effect of morphological spin-up

In Figure C.1 and C.2 it can be seen that spinning up the model reduces the initial large fluctuations in sedimentation and erosion caused by the fixed layers. In reality, one would expect that after 1 year of morphological simulation, the bed level is still relatively close to the initial bed level. Without morphological spin-up, there are big jumps in the bed level throughout the first years. The lines that show the bed level of the first few years are closer to each other for the simulation with morphological spin-up. The response of the model to the fixed layers should be noted. When comparing Figure C.1 and C.2, it can be seen that large sedimentation is induced directly downstream of the fixed layers, followed by a large erosive wave further downstream. This happens due to an initial reaction of the model to the fixed layers. Initially, the model reacts to the fixed layer at Nijmegen and the river bed groynes at Erlecom with sedimentation of up to 40 centimeters. This in turn causes a deficiency in sediment transport here and thus the flow entrains more sediment downstream. Figures C.3, C.4, C.5 and C.6 all show that both this erosive wave and the large scale sedimentation move downstream. The fact that the erosion caused by the fixed layer at Nijmegen leaves the Boven-Waal and enters the Midden-Waal, leads to a reduced average bed degradation in the Boven-Waal for the simulation with spin-up, which can be seen in Figure C.7. The simulation with spin-up has a domain averaged bed degradation in the Boven-Waal of -0.73 cm per year, which is indeed an underestimation compared to the bed degradation trends in other studies (Table 1.1). It can be concluded that the initial reaction of the model to the fixed layer at Nijmegen and the river bed groynes at Erlecom largely dictates the morphological development of the Boven-Waal. However, this has been accepted as a deficiency of the model. Even longer spinning up of the model also means that more of the actual erosion trend would already be included in the spin-up period. The creators of the DVR model recommended the used morphological spin-up of 2 years and thus this will be the reference run for this research. The data shows that the spinning-up of the model has enabled a reduction in the initial response of the model to the fixed layer and river bed groynes, but that it could not fully mitigate it. Nevertheless, these inaccuracies will be the same for all the different simulations, which means that all the data will include them. So, when comparing different simulations, meaningful results can still be inferred.

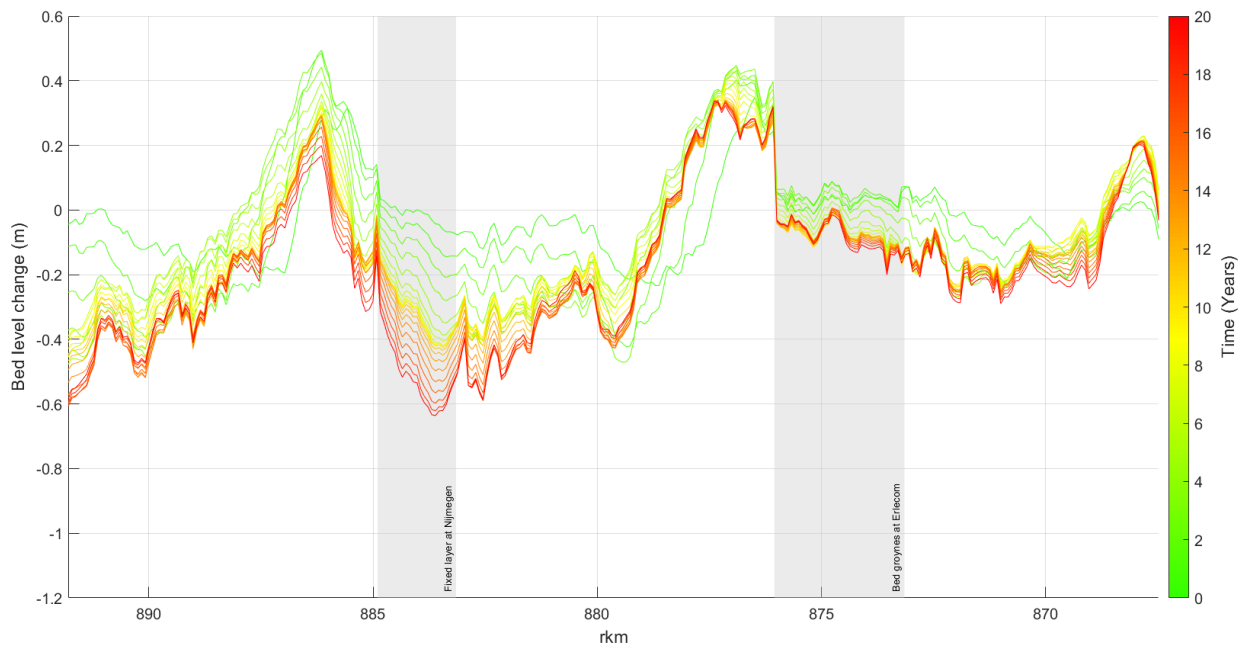

FIGURE C.1: Width averaged bed level change through the years of morphological simulation without morphological spun-up bed

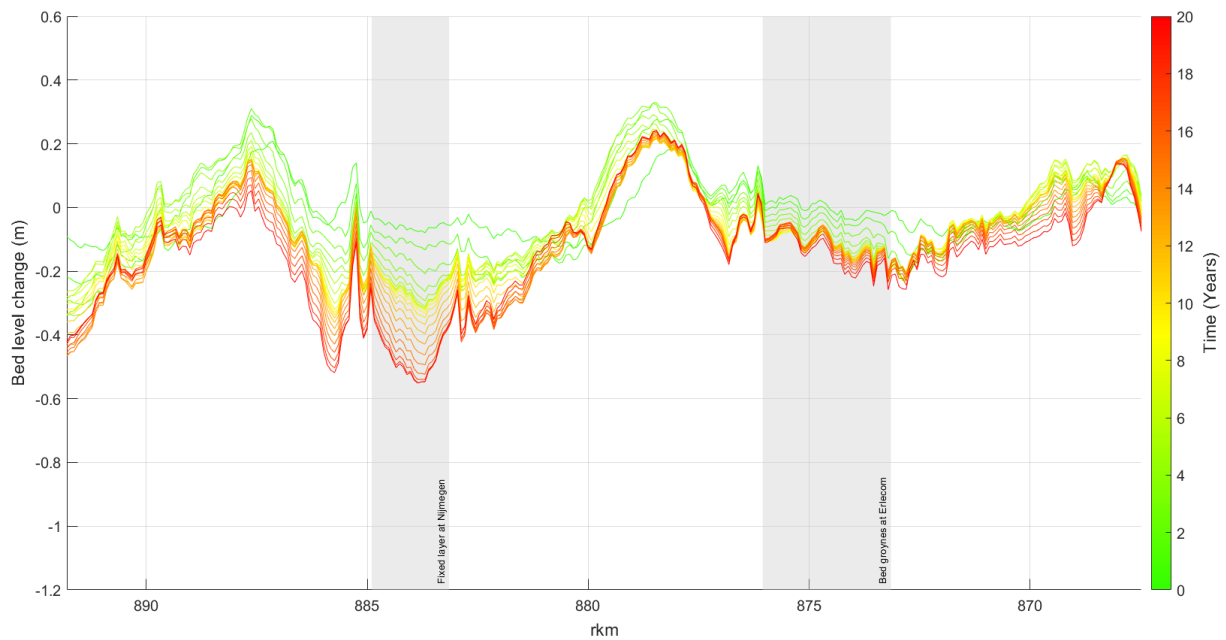

FIGURE C.2: Width averaged bed level change through the years of morphological simulation with morphological spun-up bed

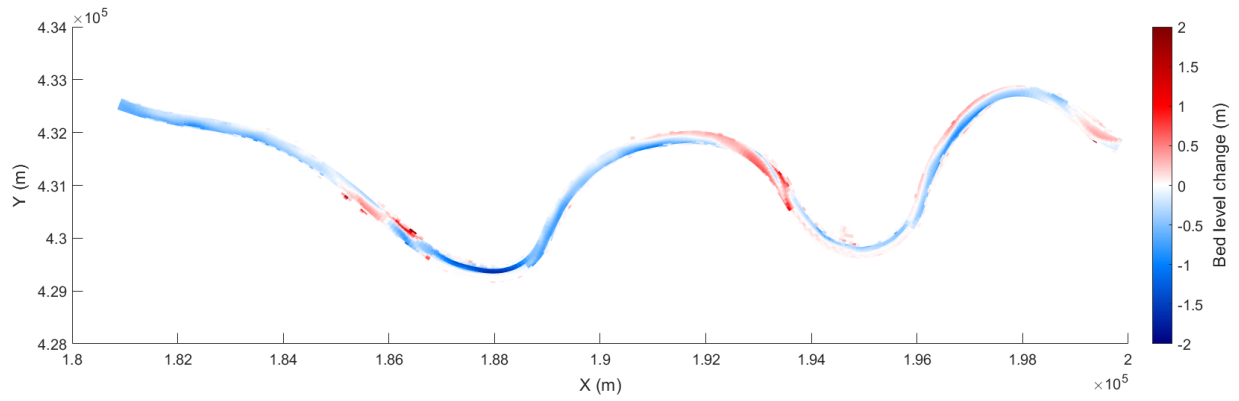

FIGURE C.3: Bed level change after 20 years of morphological simulation without morphological spun-up bed

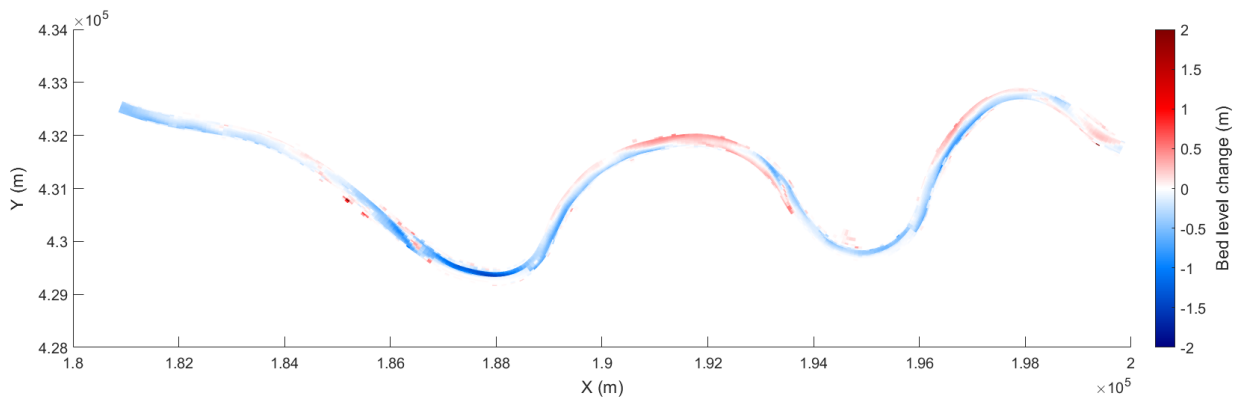

FIGURE C.4: Bed level change after 20 years of morphological simulation with morphological spun-up bed

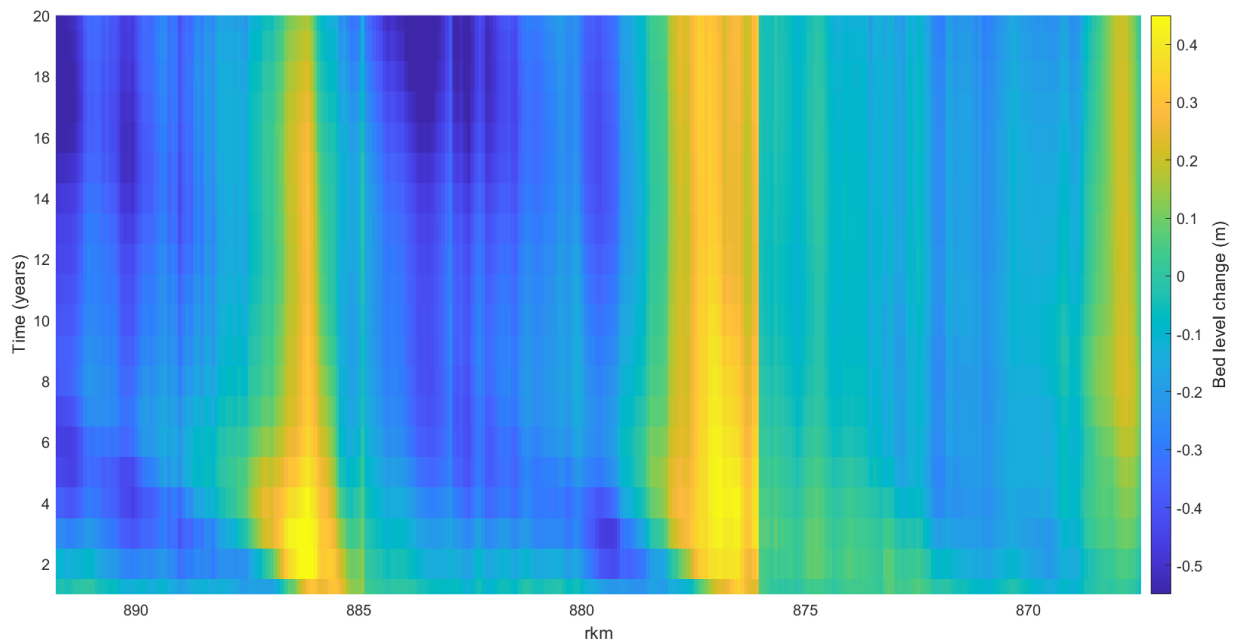

FIGURE C.5: Bed level change through time and space without morphological spun-up bed

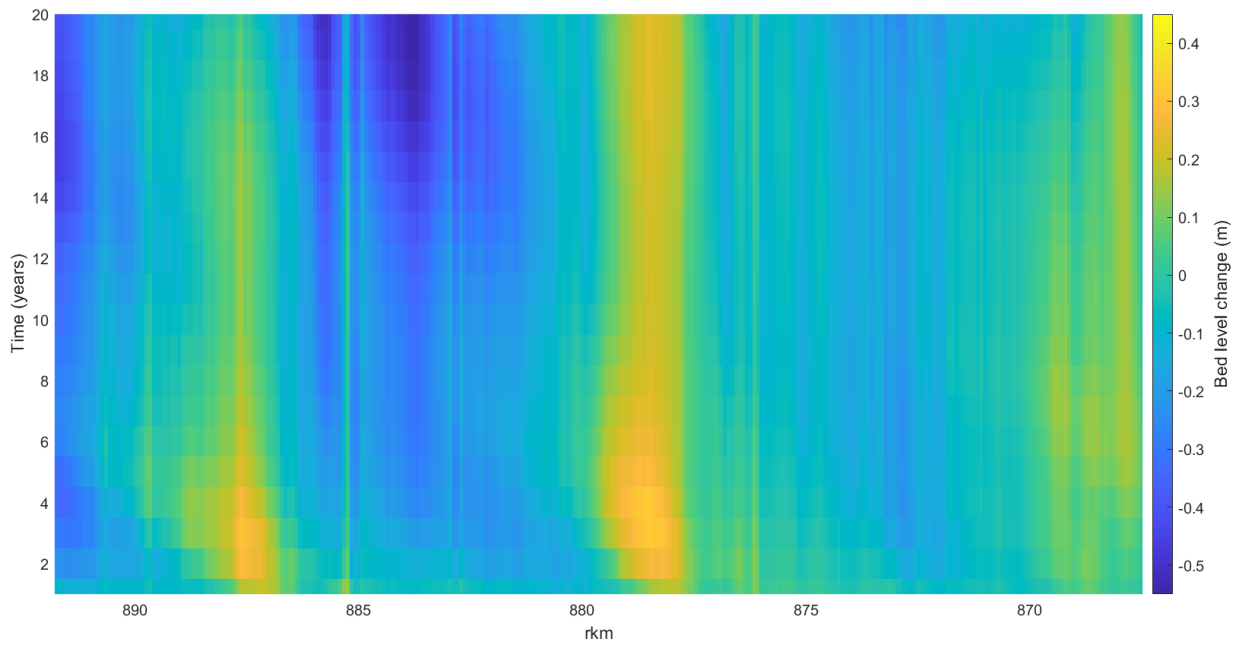

FIGURE C.6: Bed level change through time and space with morphological spin-up bed

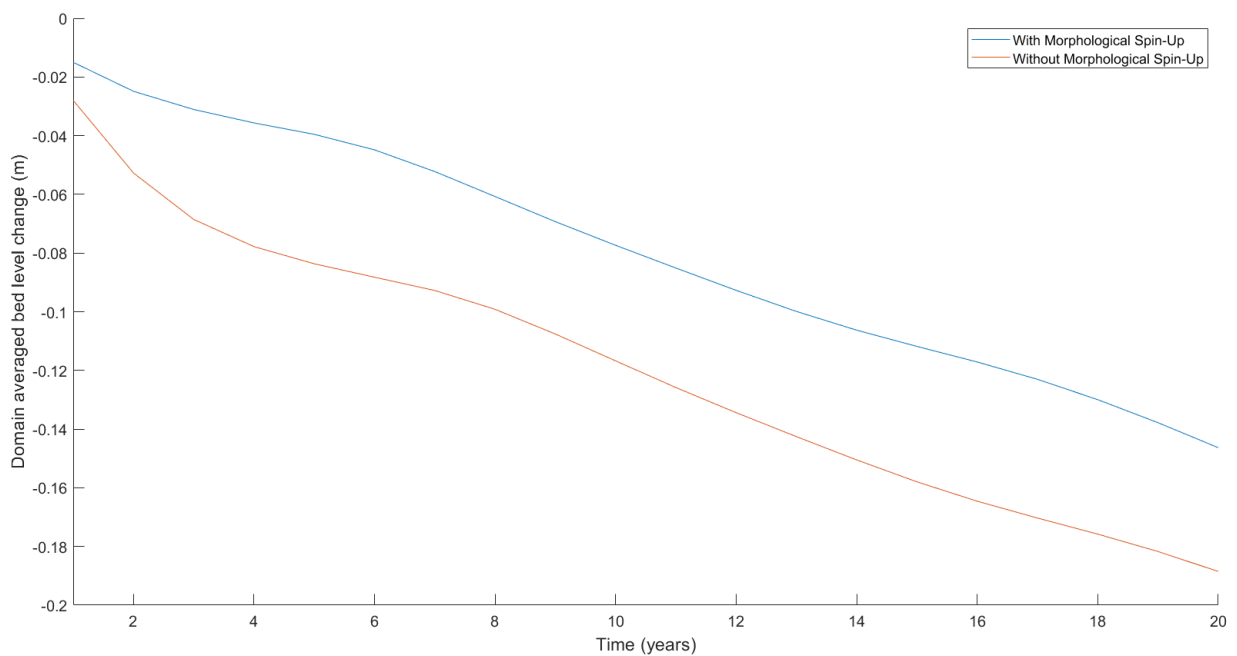

FIGURE C.7: The development of the domain averaged bed degradation in the Boven-Waal, with (blue) and without (orange) morphological spin-up.

D | Elaboration on the implementation of the different river interventions in the DVR model

When input files of a Delft3D model are changed, this is usually done via Baseline. First the proposed river intervention is schematized in GIS in the Baseline protocol belonging to the used model. Then using Baseline, this GIS schematization is converted to Delft3D input files, which essentially averages data over grid cells and snaps data to the grid cell edges. In this research, the proposed river interventions were adapted manually. The GIS schematization belonging to the input files of the used version of the DVR model (version `delft3d_4-rijn-j18-v0`) was loaded into ArcMap (10.6.1). This was done, as the input files of the DVR model are large text files that each contain information about a certain characteristic of a grid cell or its edges. By visualizing the input in ArcMap, it creates understanding about which lines in the input text files correspond to what feature in the GIS schematization. By constantly comparing these two, it enables to change the text files so that the proposed river intervention is exactly implemented in the model how one envisioned it in ArcMap.

For the implementation of the proposed river interventions in this research, 6 types of input files needed to be changed. These input files being:

- Roughness in the U-direction (.aru files)
- Roughness in the V-direction (.arv files)
- Bathymetry (.dep files)
- Sediment layer thickness (.thk files)
- Sediment fractions (.frc files)
- Weirs (.wr files)

In order to understand how to change the input files, an understanding of the computational grid is required. Figure D.1 shows how a computational grid cell functions in the DVR model. A certain grid cell is indicated by an m and n value. These m and n values are also used in the input files of the DVR model. It is important to understand which information belonging to a certain grid cell (m,n) is projected where on the computational grid cell. For instance, bed levels, sediment layer thickness and sediment fractions are projected on the top left corner of a certain grid cell (Figure D.1). Moreover, weirs and roughness values are projected on the velocity points that are present on the edges of a grid cell. Depending on the direction in which they constrict the flow in reality, they are projected on either the top edge (U-direction) or the left edge (V-direction) of the grid cell (Figure D.1). Lastly to complete the story, the water level points are located in the middle of a grid cell, but no information projected on these water level points is changed in the adaptation of the input files.

For the combined intervention of lowering the summer dikes and implementing side channels, the weir (.wr), roughness (.aru/.arv) and bathymetry (.dep) files have been changed. First, the weirs present in the intended new side channels are deleted. The intended side channels are visualized

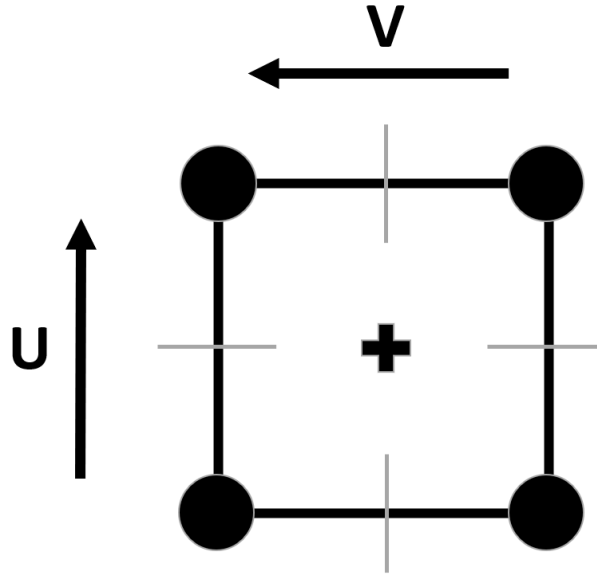

FIGURE D.1: An overview of a grid cell of the DVR model. The bathymetry (.dep), sediment layer thickness (.fc) and sediment fractions (.frc) are defined on the black circles on the corners of a grid cell. The weirs and roughness values are defined in the velocity points, indicated by the grey lines on the edges of the grid cell. The black cross in the center indicates the water level point. The arrows in the sides show the longitudinal (V or n direction) and the cross-sectional (U or m direction)

in Figure D.2. Here the grid cells of which the intended side channels will consist of, are made transparent. Subsequently, the weirs that are still in the input files and represent summer dikes are deleted. Hereby, the summer dikes are lowered to the surrounding landscape. Figure D.3 shows which weirs have been deleted for the implementation of summer dike lowering and side channels. Now, it was made sure that the side channels have a Nikuradse roughness height of 0.2 meter. This was done by changing the roughness files (.aru/.arv). Depending on the direction the water has to flow to in the side channels, either the roughness in the U and/or V direction was changed. This has been done for all transparent grid cells in Figure D.2. Lastly, the bathymetry file (.dep) was changed (Table 3.2), such that the bed level of the side channels corresponds to the height of the lower lying areas in the floodplains that the side channel aims to connect to the main channel. Depending on the direction of the flow, the model takes an average bathymetry of the two bed levels present on the edges of the grid cell (Figure D.1). Therefore, the bathymetry in some dark grid cells adjacent to the transparent grid cells in Figure D.2 have been changed as well. This again lowers the bathymetry adjacent to that grid cell. Due to the coarse grid in the floodplains, this immediately affects quite some area in the floodplains.

Lowering of the groynes only required changes to the weir file (.wr). Figure D.4 shows which weirs have been changed for this river intervention. The changed weirs are not deleted in this case, instead there heights are lowered to +1.20 OLR 2022.

The implementation of longitudinal training dams was less straight forward. It required changes in the bathymetry (.dep), roughness (.aru/.arv), weir (.wr), sediment thickness (.thk) and sediment fraction (.frc) files. Figure D.5 shows the grid cells of which the LTDs consist of. The LTDs have a width of 4 grid cells in the cross-sectional direction and the most inward grid cell of the LTD is located one grid cell further in the main channel than the original groyne tips. First, all present weirs within the grid cells of the intended LTDs are deleted. Subsequently, weirs are added to the

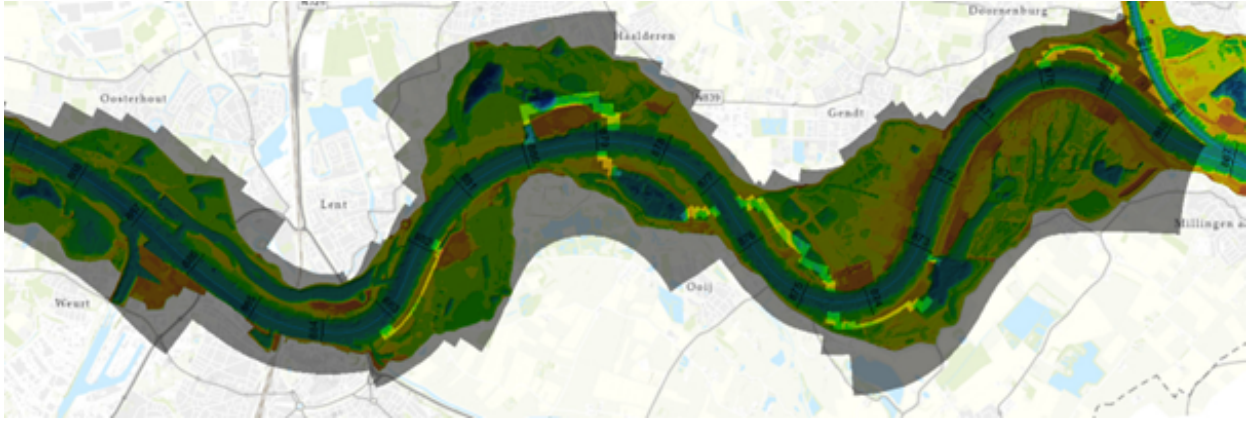

FIGURE D.2: The location of the implemented side channels is visualized by making the grid cells of which they consists of transparent. The black colour shows unchanged grid cells.

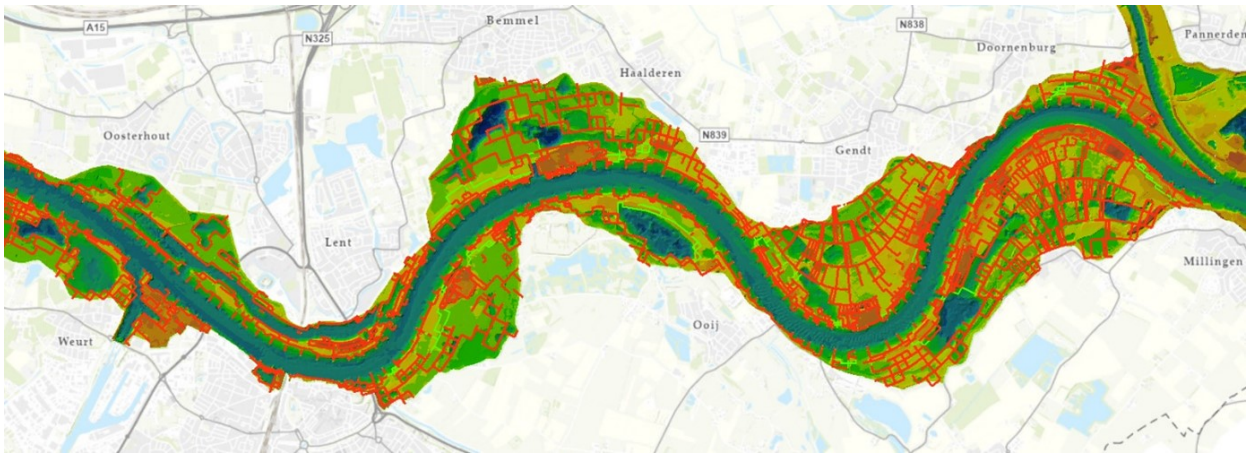

FIGURE D.3: The weirs deleted for the implementation of side channels and lowering of summer dikes are shown in green. The weirs with a red colour have not been changed.

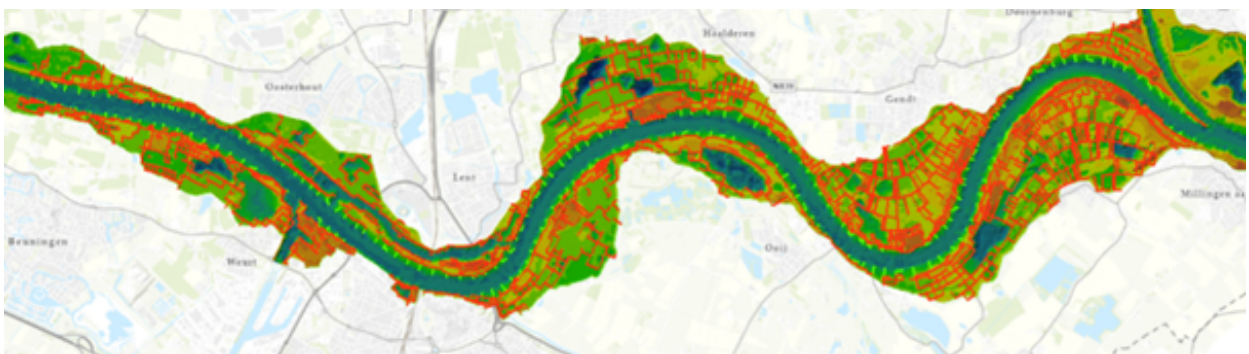

FIGURE D.4: The weirs that are changed for the lowering of groynes are shown in green. These weirs have been lowered to +1.20m OLR 2022. The weirs with a red colour have not been changed.

start of the LTD to make a sill. A weir in the V-direction was added to the four most upstream grid cells. A weir in the U-direction was added to the most inward grid cells, all the way to the end of the LTD. The first two of these weirs in the U-direction are also part of the sill. All the downstream weirs from here form the LTD crest. Figure D.6 visualizes these grid cells and their

weirs. The weirs of the sill have a height corresponding to 0.50 meter +OLR and the LTD crest has a height corresponding to 2 meter +OLR. Similar to the implementation of side channels, the Nikuradse roughness heights have been changed. Those of the Riparian channel were changed to a Nikuradse roughness height of 0.2 meter. The Nikuradse roughness height of the LTD crest was set to 0.4 meter. The bathymetry of the LTD crests were also changed to the same height as the weir on most inward grid cells, which is OLR 2022. The bathymetry of the riparian channels was set to the average height in the main channel parallel to it (Figure D.6). Lastly, the LTD crests and their riparian channels were designed to not contain sediment at the start of the simulation. This ensures that the LTD itself will not erode during the simulation, as the model can only erode what is deposited during the simulation, if there is no initial sediment layer present. This is achieved by setting the sediment layer thickness and sediment fractions in the corresponding grid cells to zero. For the Boven-Waal, this change has to be made in 77 files, as each domain has 7 sediment layers, which consist of 11 sediment fractions each. Figure D.6 shows which grid cells are subject to this change. It can be noticed that an extra grid cell is made non-erodible at the inside of the LTD. This was done, as this cell contains the slope of the LTD, which is also visible in Figure D.6.

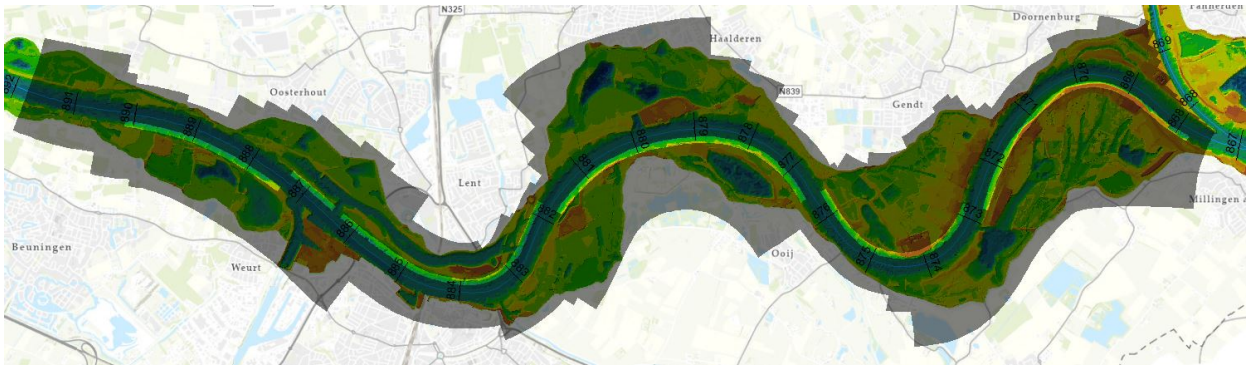

FIGURE D.5: The location of the implemented longitudinal training dams is visualized by making the grid cells of which they consists of transparent. The black colour shows unchanged grid cells.

The input files for simulations that include multiple interventions are achieved by combining the input files of the previously explained isolated interventions. In some cases there are minor conflicts between the interventions. The first case being the necessary removal of inner bend groynes for the implementation of LTDs. So if LTDs and groyne lowering are combined, only the groynes that are not located at the same locations as the LTDs are lowered. The second case is when side channels and LTDs are implemented simultaneously. The inlet and outlet of inner bend side channels conflict with the continuous LTDs along the inner bend. This is solved by breaking up the LTD at these locations. The bathymetry of the riparian channel of the LTD is extended over the previous inlet and outlet of these inner bend side channels. After the inlet, a new sill is implemented and the LTD continues as normal. Figure D.7 visualizes this process.

Figure D.8 shows an example of how $Sim_{SC-GL-LTD}$ was schematised between river kilometer 876 and 877. $Sim_{SC-GL-LTD}$ combines LTDs, groyne lowering, side channels and summer dike lowering (Table 3.1). Figure D.8 shows the end of an LTD, where also a side channel flows out into the main channel again, the start of an LTD, with an L-shaped sill, where also a side channel bifurcates from the main channel. Additionally, three groynes are visible, which are lowered in this simulation.

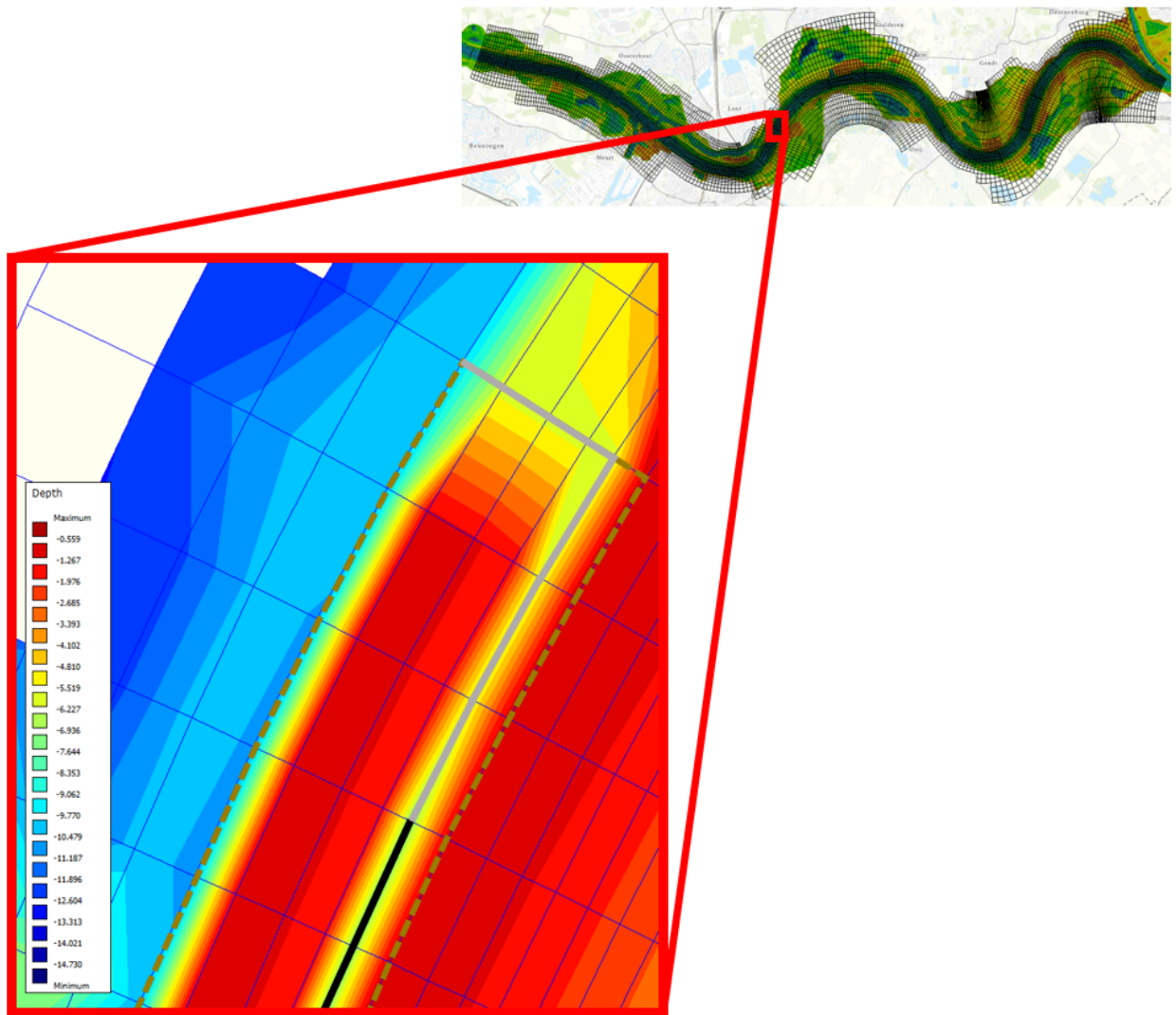

FIGURE D.6: An example of how an LTD is schematized at rkm 882. The colours in the legend, ranging from dark blue to dark red, show the bathymetry. The black line represents the crest of the LTD and the grey line represents the sill of the LTD. The grid cells within the dashed brown polygon are the ones that were made to not contain a sediment layer.

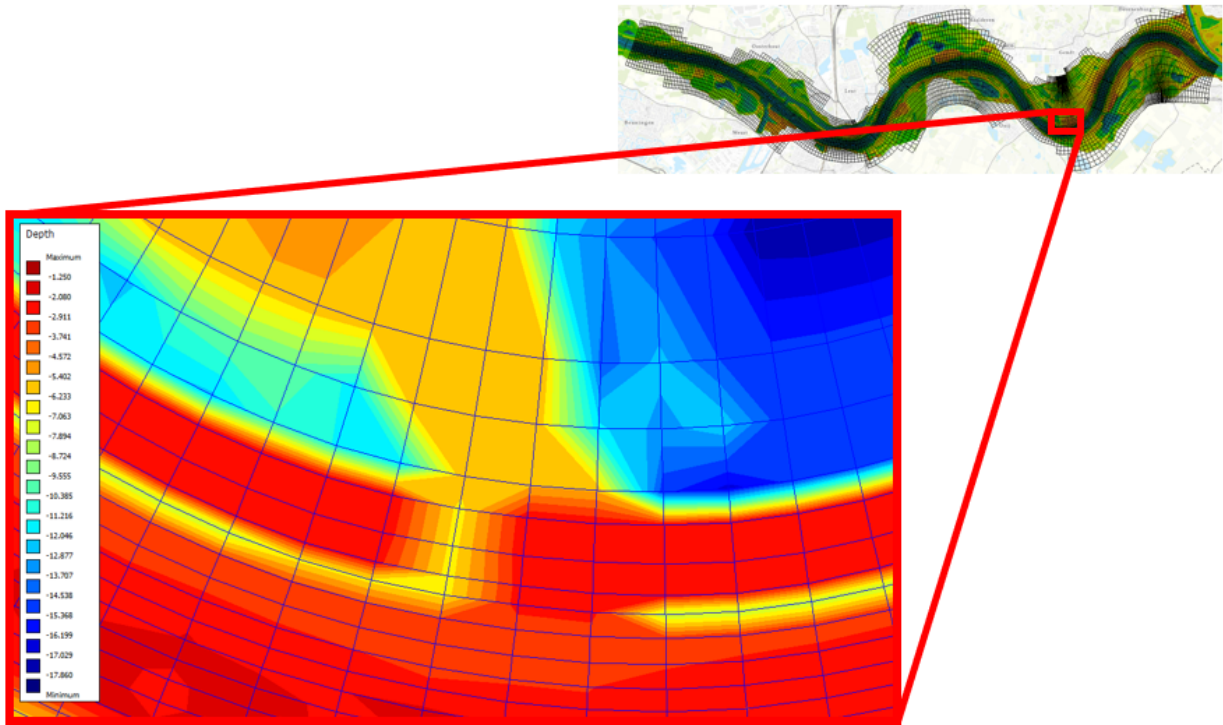

FIGURE D.7: An example of how an LTD is broken up to let a side channel bifurcate from the main channel at rkm 875. The yellow lines in the main channel are the LTDs. The LTD on the right is ending. The LTD is continued on the left with a new sill. The orange polygon is a bifurcating side channel that connects to a lake in the floodplain.

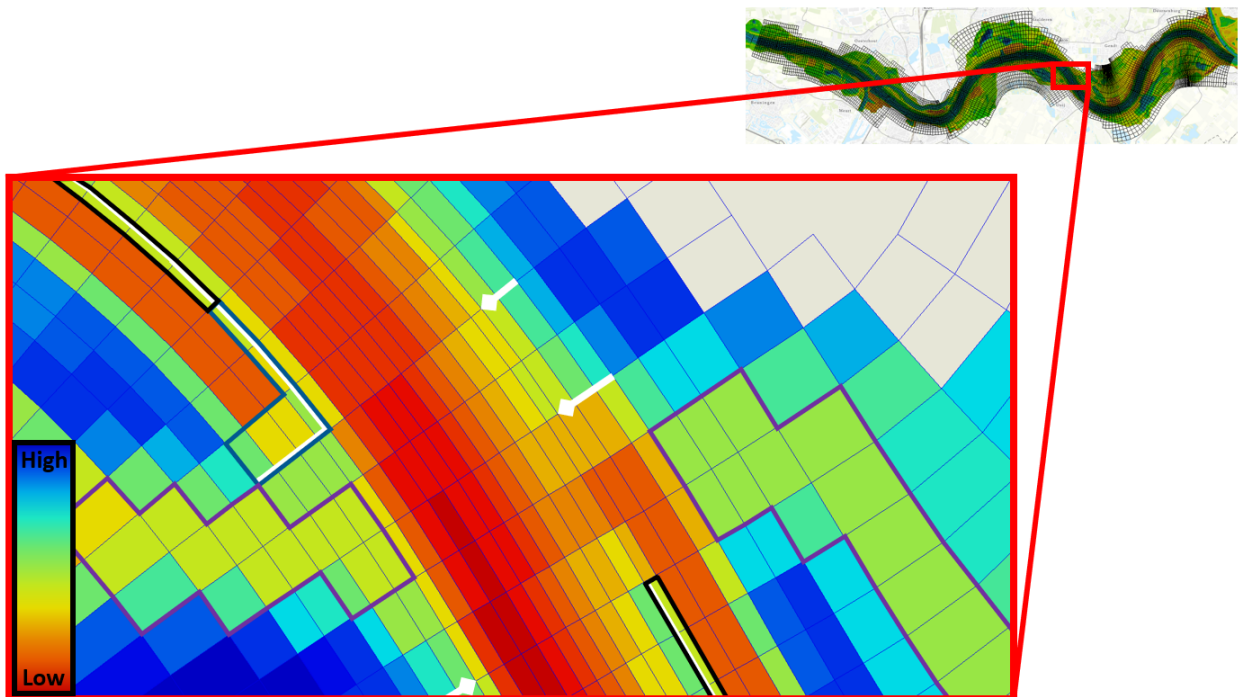

FIGURE D.8: An example of how $\text{Sim}_{SC-GL-LTD}$ is schematized between rkm 876 and 877. The colours indicate the elevation of the grid cells. The black polygons represent the crest of an LTD, the dark blue polygon represents the sill of the LTD, the purple polygons represent side channels and the white lines represent weirs. The white lines with a square at the tip are also weirs in the model schematization, but specifically represent groynes in this figure.

E | Bed level development after 5, 10 and 15 years for the reference simulation

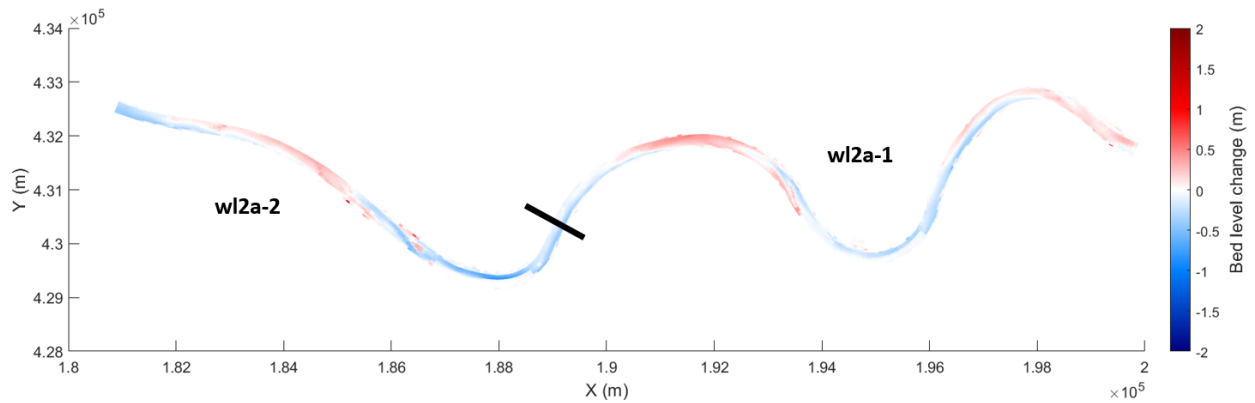

FIGURE E.1: Bed level change after 5 years for Sim_{REF}

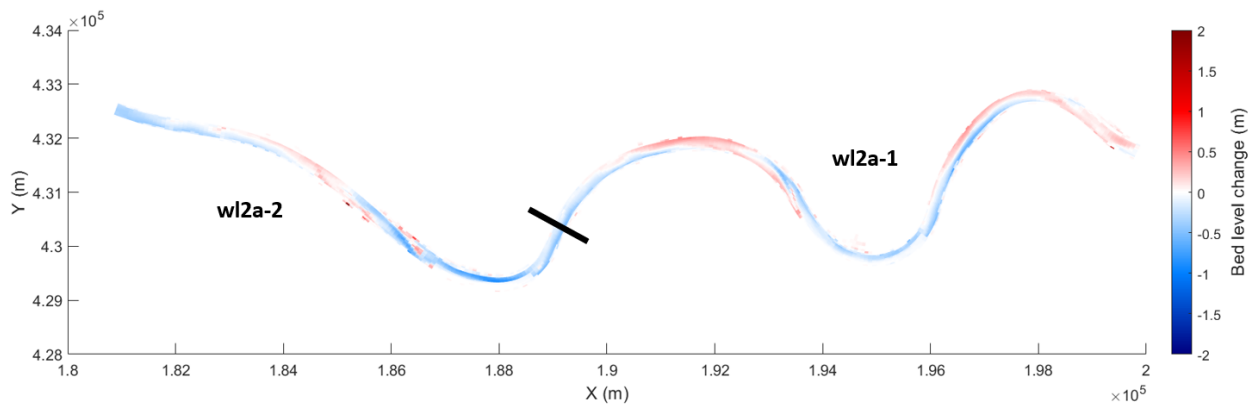

FIGURE E.2: Bed level change after 10 years for Sim_{REF}

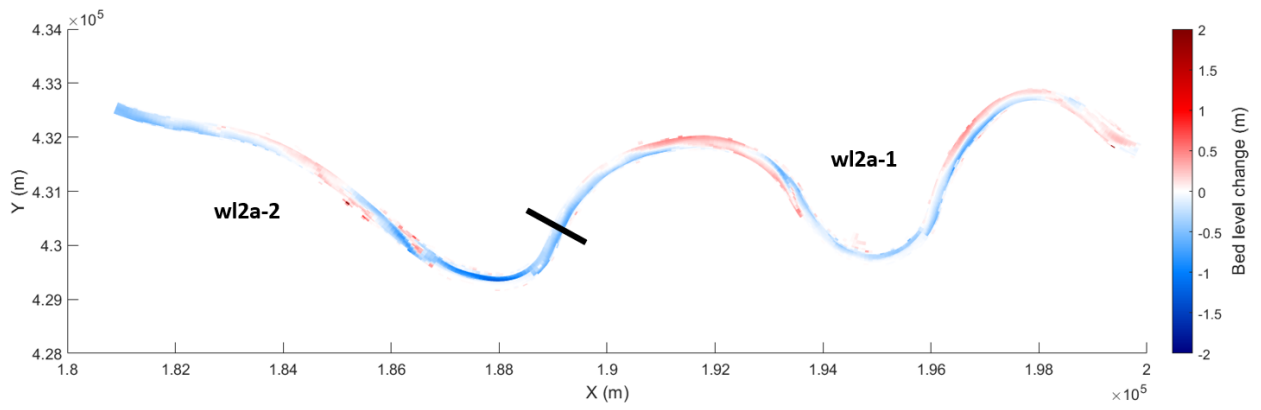

FIGURE E.3: Bed level change after 15 years for Sim_{REF}

F | Bed level development after 20 years for each simulation

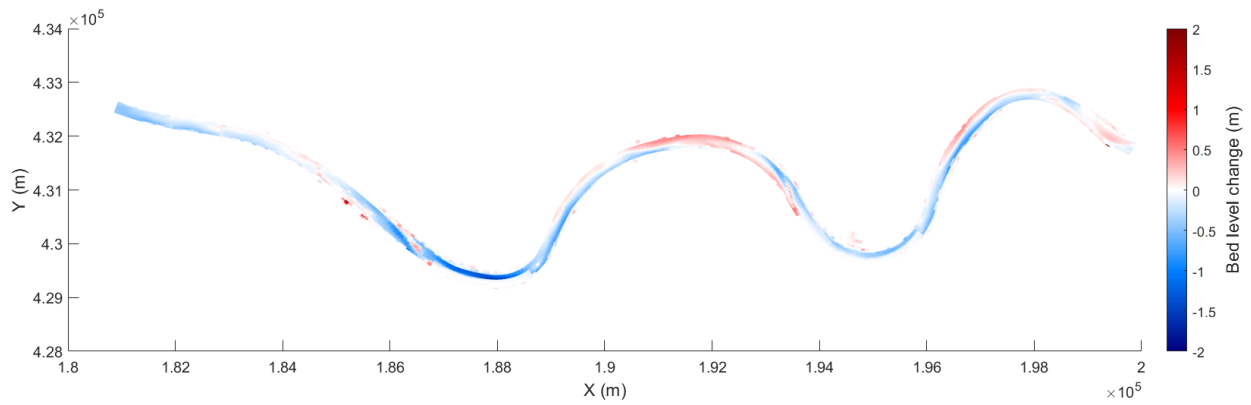

FIGURE F.1: Bed level change after 20 years for Sim_{REF}

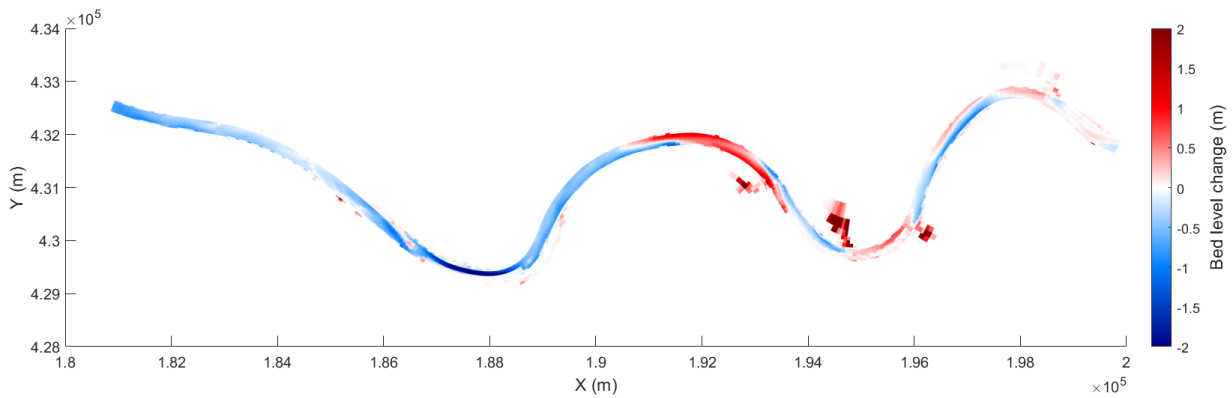

FIGURE F.2: Bed level change after 20 years for Sim_{SC}

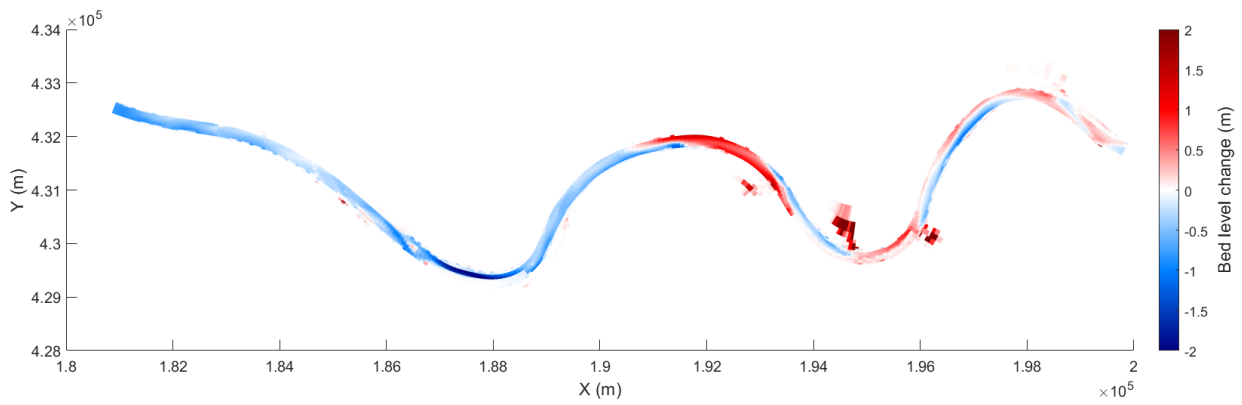

FIGURE F.3: Bed level change after 20 years for Sim_{SC-GL}

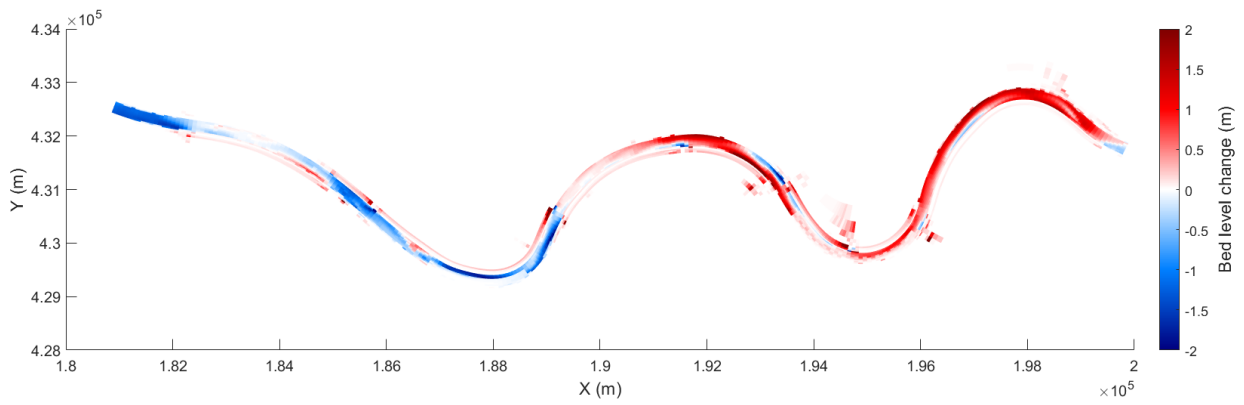

FIGURE F.4: Bed level change after 20 years for $\text{Sim}_{SC-GL-LTD}$

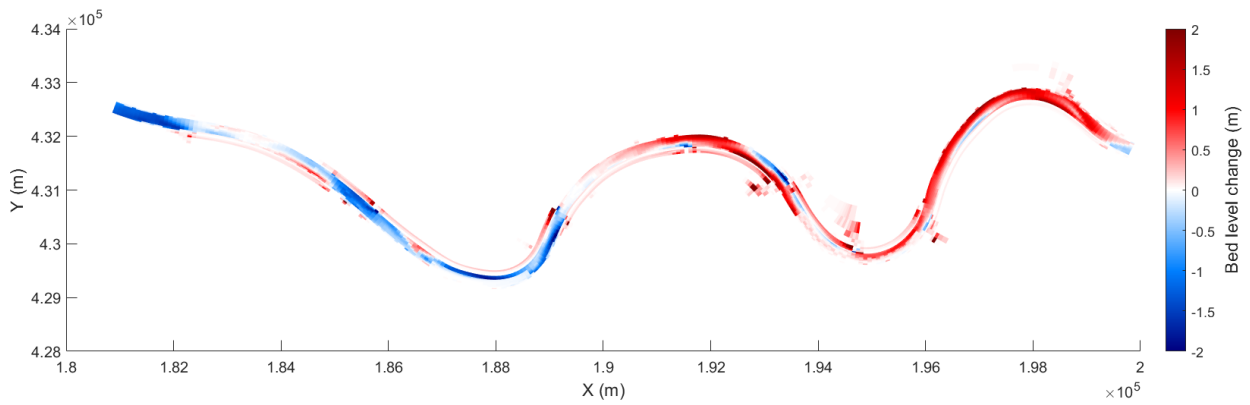

FIGURE F.5: Bed level change after 20 years for Sim_{SC-LTD}

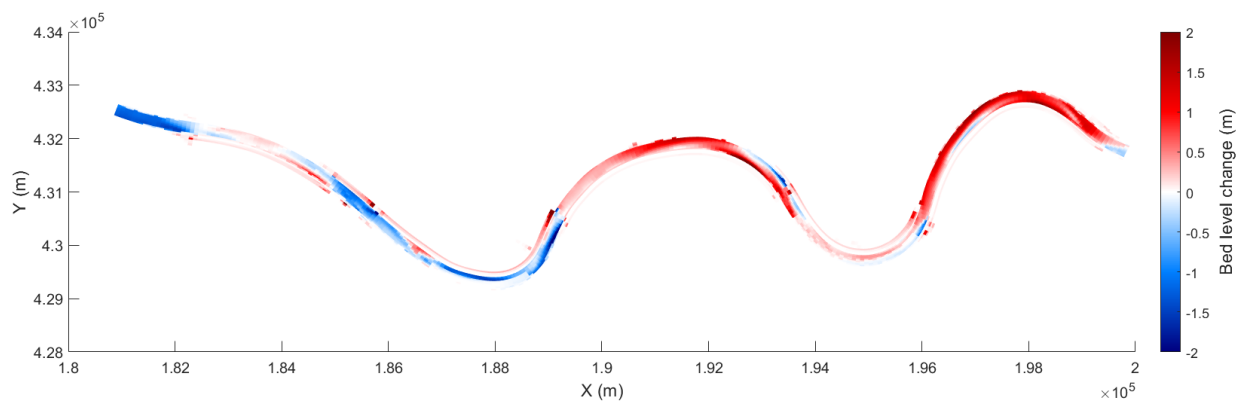

FIGURE F.6: Bed level change after 20 years for Sim_{GL-LTD}